

KENWOOD

144/430 MHz FM Dual Bander

144/440 MHz FM Dual Bander

TH-78A

144/430MHz FM Dual Bander

TH-78E

INSTRUCTION MANUAL

KENWOOD CORPORATION

©PRINTED IN JAPAN B62-0248-60(W)(MC)
94/6 5 4 3 2 1 93/12 11 10

Models Covered In This Manual

- TH-78A : 144/440MHz FM Dual Bander with CTCSS unit (U.S.A. and Canadian version)
- TH-78A : 144/430MHz FM Dual Bander (Other markets)
- TH-78E: 144/430MHz FM Dual Bander (U.K.and European version)

Find It Fast

For quick access to transceiver features and functions, consult these handy listings:

- Contents (page 3)
- Quick Reference (page 69, 70 and 71)

ATTENTION (U.S.A. only)

Nickel-Cadmium batteries must be recycled or disposed of properly. State laws may vary regarding the handling and disposal of Nickel-Cadmium batteries.

Please contact your authorized KENWOOD Dealer for more information.

Notice to the user:

One or more of the following statements may be applicable to this equipment.

FCC WARNING

This equipment generates or uses radio frequency energy. Changes or modifications to this equipment may cause harmful interference unless the modifications are expressly approved in the instruction manual. The user could lose the authority to operate this equipment if an unauthorized change or modification is made.

Information to the digital device user required by the FCC:

This equipment has been tested and found to comply with the limits for a Class B digital device, pursuant to Part 15 of the FCC Rules. These limits are designed to provide reasonable protection against harmful interference in a residential installation. This equipment generates, uses and can generate radio frequency energy and, if not installed and used in accordance with the instructions, may cause harmful interference to radio communications. However, there is no guarantee that the interference will not occur in a particular installation. If this equipment does cause harmful interference to radio or television reception, which can be determined by turning the equipment off and on, the user is encouraged to try to correct the interference by one or more of the following measures:

- *Reorient or relocate the receiving antenna.*
- *Increase the separation between the equipment and receiver.*
- *Connect the equipment into an outlet on a circuit different from that to which the receiver is connected.*
- *Consult the dealer for technical assistance.*

CONTENTS

ACCESSORIES	5	7 Entering The Call Channel Frequency	21
BEFORE OPERATION	5	8 Recalling Memory Channels	22
Controls Overview	6	9 Memory Shift	22
THE BATTERY PACK		10 Memory Channel Character Display.....	23
1 NiCd Battery Pack (PB-13).....	8	SCANNING	
2 Recharging	8	1 Hold/Resume Programming	24
3 Installing The Battery Pack.....	8	2 Scan operation cancel.....	24
4 Battery Voltage Level	9	3 Scan Options	25
5 Battery Operating Time	9	4 Scanning Memory Channels	25
RECEIVER OPERATION		5 Scanning Band.....	26
1 Getting started	10	6 Programmable Band Scan.....	26
2 Tuning Control and Volume Control	10	7 MHz Scan	27
3 Selecting Frequency	12	8 VFO/Memory Scan	27
4 Step Size Selection	14	9 CALL/VFO Scan	28
5 Programmable VFO Tuning Limits	15	10 CALL/Memory Scan	28
6 Basic Receiving Functions	16	11 V/M/C(VFO/Memory/CALL) Scan.....	28
TRANSMITTER OPERATION		12 The Alert Function	28
1 To transmit	17	REPEATER OPERATION	
2 Changing Transmitter Output Power	17	1 Transmitter Offsets	29
3 TX. Stop Function	18	2 Selecting the Offset Direction.....	29
4 Time Out Timer	18	3 Automatic Offset Selection	29
USING THE MEMORY		4 Manual Offset Selection	30
1 Microprocessor Memory Backup	19	5 The Reverse Function	30
2 Initializing The Memory	19	6 Tone Operation.....	31
3 Memory Channel	19	7 Autopatch Operations	32
4 Memory Contents.....	20	8 DTMF Memory	33
5 Entering Memory Data.....	20	OPERATION AS A REPEATER	34
6 Entering Split Channel Frequencies.....	21	CTCSS OPERATION	35

THE DUAL TONE SQUELCH SYSTEM (DTSS)

- 1 DTSS Code 36
- 2 Using the DTSS Function 36
- 3 Using DTSS with a Repeater 37

PAGING

- 1 Paging Operation Overview 38
- 2 Paging Code Memory 39
- 3 Setting Paging Codes 39
- 4 Sending Pages (Calling) 40
- 5 Receiving Pages (Wait) 42
- 6 Canceling Signal Squelch 43
- 7 Locking Out Codes 43
- 8 Answer-Back 43

MESSAGE TRANSMISSION AND RECEPTION

- 1 Message Transmission modes 44
- 2 Using the Message Memory 44
- 3 Message Memory Check 46
- 4 Message Memory Transmission 46
- 5 Message Reception 46
- 6 Receive Message Memory 47

ENHANCED RECEIVER FUNCTIONS

- 1 The Tone Alert System 48
- 2 Monitor 49
- 3 Beep Off 49
- 4 Lamp 49
- 5 Key Lock 49
- 6 Volume adjustment when you use
an earphone 50
- 7 Switching speaker output when a speaker-
microphone is connected 50
- 8 Automatic Band Change Function 51

- 9 Simultaneous Receive Function of Two
Signal in the Same Band 51
- 10 Single Band Operation 52
- 11 MHz Mode 52
- 12 Channelized Frequency Display 52

POWER SAVER FEATURES

- 1 The Battery Saver Mode 53
- 2 Automatic Power Off (APO) 53

CLOCK FUNCTION

- 1 Time Setting 54
- 2 Timer Function 54

DUPLEX OPERATION 56

POWER ON MESSAGE AND FUNCTION MESSAGE

- 1 Power On Message 57
- 2 Function Message 57

MAINTENANCE

- 1 General Information 59
- 2 Service 59
- 3 Record Keeping 59

TROUBLESHOOTING 60

ACCESSORIES 61

- 1 Installing the CTCSS Unit (TSU-7) 63
- 2 Memory Expansion Unit (ME-1) 64
- 3 Programming the SMC-33 Remote Control
Speaker Microphone 65
- 4 Using other microphone 67

SPECIFICATIONS 68

QUICK REFERENCE 69

ACCESSORIES

Antenna	T90-0444-××
Belt Hook	J29-0465-××
Hand Strap	J69-0312-××
Rubber Cap	B09-0330-××
AC plug (M type only)	E19-0254-××
Battery Case (TH-78Q type only) ...	A02-1658-××
NiCd Battery Pack(PB-13)	W09-0563-××
Battery Charger(BC-14)	

for U.S.A. and Canada (120V)

..... W09-0565-××

for Europe (220V)

..... W09-0569-××

for U.K.version (240V)

..... W09-0568-××

for Oceania (240V)

..... W09-0567-××

for other market (120/240V)

..... W09-0566-××

Instruction Manual

B62-0248-××

Warranty Card(U.S.A.,Canada,and Europe)

CAUTION

Transmitting with the supplied antenna near other electronic equipment can interfere with that equipment. Also, transmitting near a regulated power supply may cause the power supply to output an extremely high voltage that could damage both your transceiver and any other equipment connected to the supply.

BEFORE OPERATION

Thank you for purchasing this KENWOOD transceiver. To get the most out of its many features, we suggest you read this instruction manual carefully, and keep it handy for further reference.

To get ready to transmit and receive.

- 1 Check the accessories list to be sure everything you need has been included in the package.
- 2 Charge the included NiCd battery pack, following the instructions completely before proceeding. (See page 8)

When you have everything checked out and charged, you're ready to get to the Receiver Operation section and get up and running with your new equipment. Other sections follow in a logical order to help you learn and use this transceiver to its full potential.

CAUTION

The recommended transceiver duty cycle is 1 minute of transmission and 3 minutes of reception. Longer transmissions or extended operation in the HI power mode may cause the back of the transceiver to get hot. Do not place the transceiver where the heat sink (rear panel) might come in contact with plastic or vinyl surfaces.

Controls Overview

This transceiver has different key layouts for each destination. Check the version of your transceiver first by looking at the following illustration.

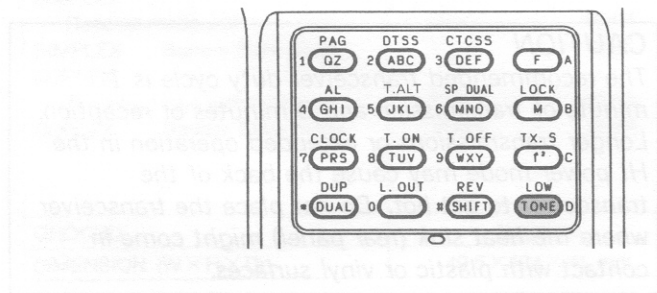
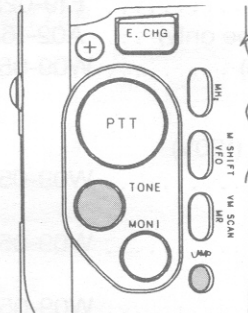
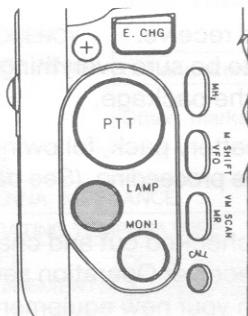

All types except U.K and European version

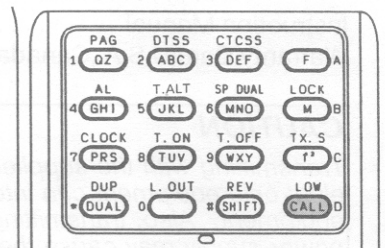

U.K and Europe version only

This diagram will help you locate the keys, switches, and knobs you'll need to perform necessary operations. Please study these controls carefully. By the time you reach the end of this manual, you will have had to use each of them many times.

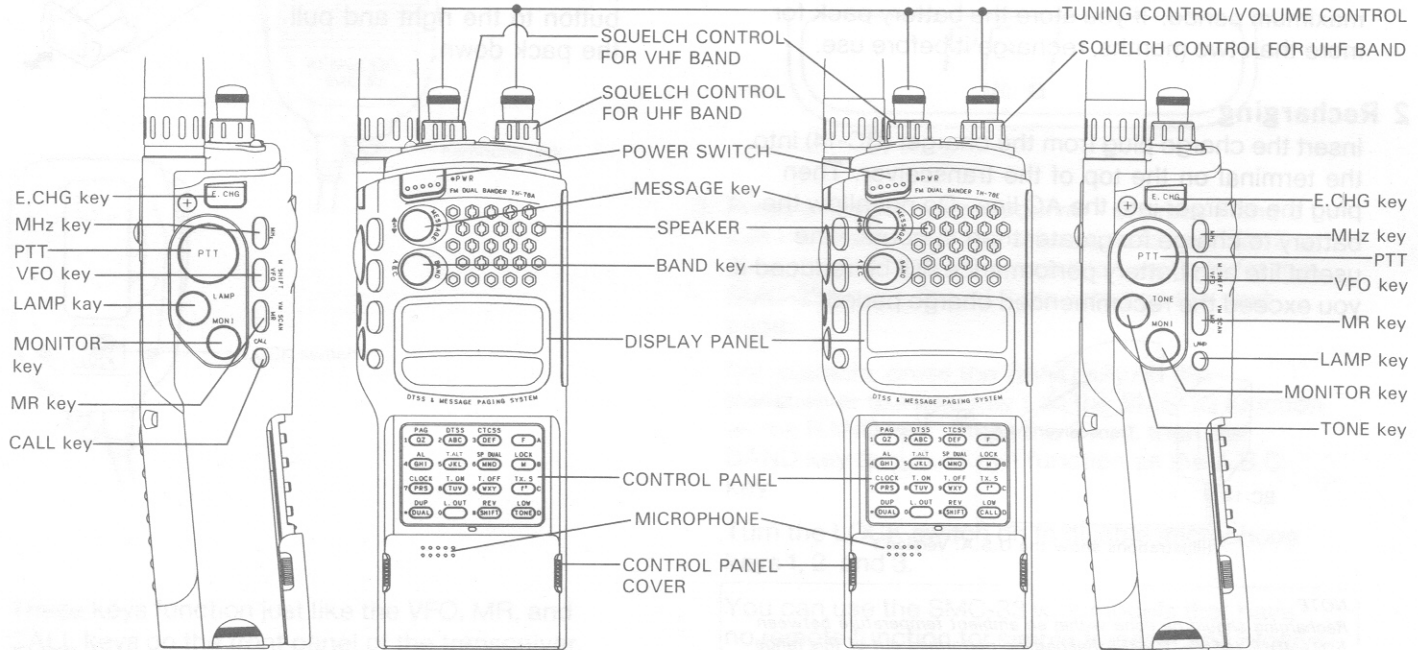
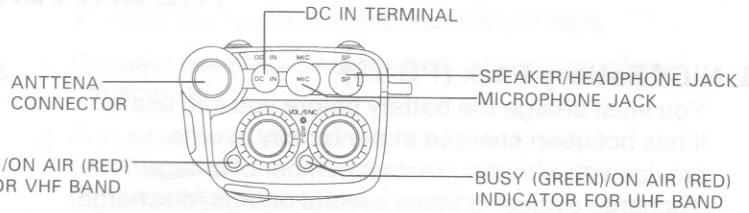

All types except U.K and European version

U.K and Europe version only

THE BATTERY PACK

1 NiCd Battery Pack (PB-13)

You must charge the battery before you can use it. It has not been charged at the factory in order to provide you with the greatest number of charge/discharge cycles. It takes several charge/discharge cycles before the battery pack will operate for its maximum period. If you store the battery pack for more than two months, recharge it before use.

2 Recharging

Insert the charge plug from the charger (BC-14) into the terminal on the top of the transceiver. Then plug the charger into the AC line. Do not allow the battery to charge for greater than 15 hours. The useful life and battery performance will be reduced if you exceed the recommended charge period.

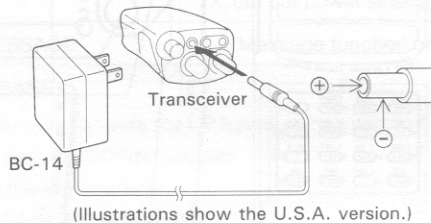

NOTE

Recharging should be done within an ambient temperature between 5°C ~ 40°C (41°F ~ 104°F). Recharging performed out of this range may not fully charge the battery.

3 Installing The Battery Pack

Insert the battery pack into the transceiver until it locks in place.

To remove the battery pack slide the Release button to the right and pull the pack down.

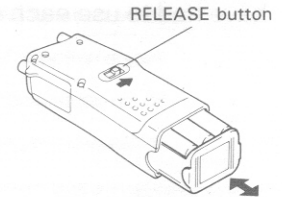





4 Battery Voltage Level Output power: EL

The meter indicates the relative battery voltage during transmit.

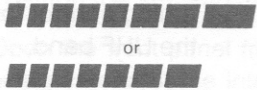
Recharge or replace the batteries when the level reaches the low indicator.

NiCd Battery pack





Fully charged	Fully discharged
 <p>or</p> 	 <p>or</p> 

Approximate battery condition

Manganese or Alkaline Batteries

Load 6 × R6 (AA) manganese or alkaline batteries in series in the optional battery case(BT-8). Be sure to observe the polarities. We recommend use of high performance Alkaline batteries.

Manganese or Alkaline batteries

New batteries	Need to change batteries
 <p>or</p> 	 <p>or</p> 

Approximate battery condition

5 Battery Operating Time (hours)

Batteries	144MHz			430/440MHz		
	H	L	EL	H	L	EL
Alkaline	7.5	13	36	6	10	32
Manganese	3	3.5	11	2	2.5	10
PB-13	4.5	7.0	20	3.5	5	14
PB-17	3	7.0	20	2.5	5	14
PB-18	7	11	31	5.5	8	22

- 6 seconds transmission, 6 seconds reception, 48 seconds reception with no signal recommended. AF output 0.2W/8 ohms.
- Battery saver function on.

CAUTION

The display indicator flashes and the POWER switch will not work when the battery starts to go flat. When this happens, recharge or replace the battery.

We recommend use of the NiCd battery pack for long transmission or extended operation. Manganese batteries (except Alkaline manganese batteries) may be used for Low or EL position.

RECEIVER OPERATION

1 Getting Started

Connect the battery pack and the supplied antenna.

Press the POWER switch to turn the transceiver on. One of the default frequencies should appear on the display.

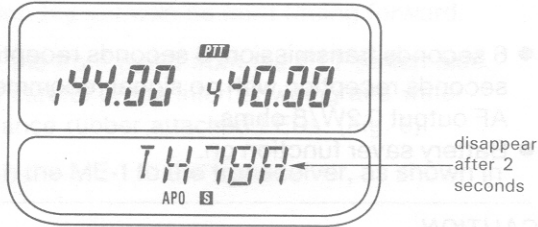

or



If the display shows incomplete data, or you think the displayed frequency is wrong, reset the micro-processor Memory Initialization (see page 19)

2 Tuning Control and Volume Control

This transceiver assigns two volume and tuning control functions to the two controls.

Before proceeding to the next step, master these functions. The default setting is as follows:

Functions as the volume control for the UHF band.

Functions as the tuning control for the UHF band.

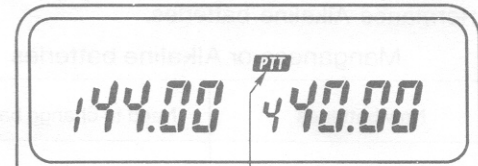
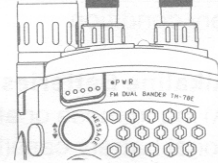

You can control the band for which the PTT indicator lights.

When you press the BAND key, control of each function is transferred to the VHF band.

When you press and hold the E.CHG key (or within two seconds of pressing the E.CHG key), each control temporary control of the volume or tuning control passes to the VHF band.

We recommend that you use this function in order to temporarily change the volume or frequency of the normally uncontrolled band.

Separate volume control function

Press the F key then press the E.CHG key.

Functions as the volume control for the VHF band.

Functions as the volume control for the UHF band.

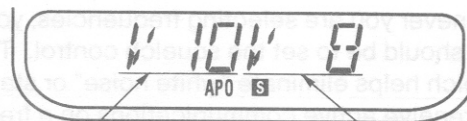
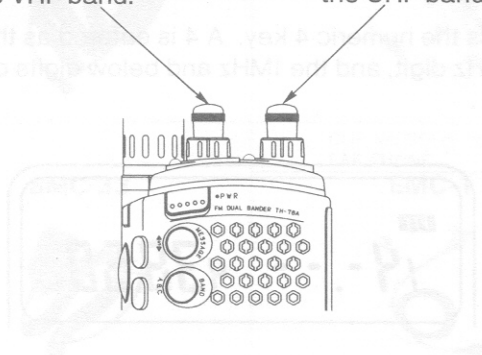

VHF BAND

UHF BAND

This indicates the volume level.

Separate tuning control function

While operating the separate volume control mode, press the F key then the E.CHG key.

Functions as the tuning control for the VHF band.

Functions as the tuning control for the UHF band.

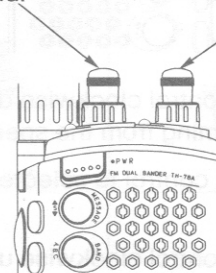

Returning to the original mode.

Press the F key for longer than one second then press the E.CHG key.

Whenever you are selecting frequencies, your first step should be to set the squelch control. The squelch helps eliminate “white noise” or static until you receive active communications on a frequency.

There are two squelch controls, one for the UHF band and one for the VHF band. To set the squelch controls:

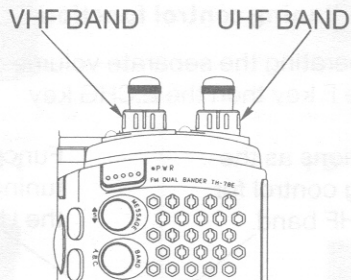

- 1 Rotate the VOL control clockwise until a signal or noise is heard coming from the speaker.
- 2 Rotate the tuning control to selected an open channel.
- 3 Rotate the SQL control clockwise until the noise just disappears and the BUSY indicator turns off. This point is known as the Squelch Threshold point.
- 4 Press the BAND key.
- 5 Repeat steps 1 to 3, and adjust the squelch of the other band.

3 Selecting a Frequency

You have several ways to select frequencies:

- By entering a specific frequency via the keyboard
- By using the tuning control
- By selecting a memory channel (see page 22)
- By pressing the CALL key

Direct Keyboard Frequency Entry

You can enter specific frequencies directly into the transceiver. If you don't have a particular frequency to enter, we suggest you try 145.050MHz.

- 1 Press the BAND key to change the primary band from UHF band to VHF band.
- 2 If the transceiver is in the Memory mode or CALL mode, press the VFO key to select the VFO mode.
- 3 Press the numeric 4 key. A 4 is entered as the 10MHz digit, and the 1MHz and below digits change to —.

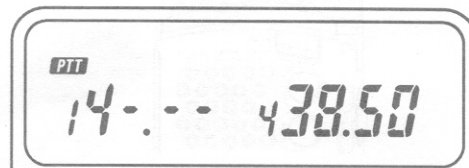

- 4 Press numeric keys 5, 0, 5, and 0.

For the European version and some other markets, you must enter the 1MHz digit first. So, first press numeric key 5.

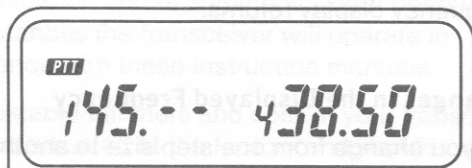

Next press numeric keys 0 and 5.

- 5 The transceiver actually changes frequency only after the 1 kHz digit is entered. The 1 kHz digit is not displayed if it is a zero.

If you do not enter the 1 kHz digit, the indicator flashes and the transceiver defaults to the previous operating frequency.

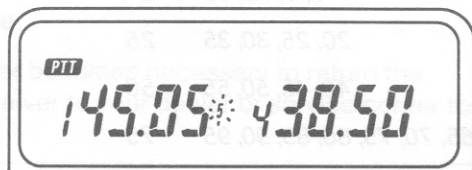

Notes

- 1 If the frequency step of the UHF band is 10 or 20 kHz, the 1kHz digit becomes zero automatically when you enter the 10kHz digit.
- 2 If you press an invalid key, the valid value nearest to that number is entered.
- 3 If you do not press a key within 10 seconds, the normal frequency display returns.
- 4 If you press the VFO key during input, the digits showing — return to the values that appeared before the direct entry mode was selected.

If the frequency step is 12.5 or 25 kHz, the input ends with the 10-kHz digit. The 10-kHz keys and frequencies set with the keys are listed below.

Key	Frequency	Key	Frequency
0	00	5	50
1	12.5	6	62.5
2	25	7	75
3	37.5	8	87.5
4	37.5	9	87.5

Using the Tuning Control

The tuning control selects frequencies in up or down sequentially.

Rotate the tuning control clockwise or counterclockwise to select the desired operating frequency.

4 Step Size Selection

The transceiver must be in the VFO mode to select frequency steps.

To select the desired tuning or scan step size use the following procedure:

- 1 Press the F key for longer than one second then press the 3 key. The current frequency step size will be displayed.

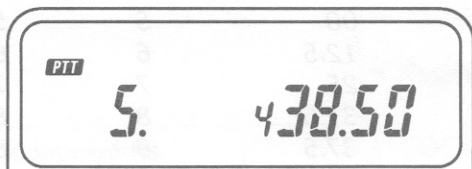

- 2 Rotate the Tuning control until the desired tuning step size appears in the display. The frequency step is indicated in the chart below.

VHF BAND 5→10→15→20→12.5→25→5

UHF BAND 10→20→12.5→25→10

- 3 Press the any key except POWER, LAMP and MONI key.

The displayed step size is set, and the normal frequency display returns.

Changes in the Displayed Frequency

As you change from one step size to another, the displayed frequency also changes, as illustrated in the accompanying charts.

For example, assume you are presently displaying 439.920 MHz at a 20kHz step size. If you were to change the step size to 12.5kHz, the display would read 439.925 MHz.

From step size 5, 10, 15, or 20	To step size 12.5 or 25
<i>Frequencies</i>	<i>Display as</i>
0, 5, 10, 15	0
20, 25, 30, 35	25
40, 45, 50, 55	50
60, 65, 70, 75, 80, 85, 90, 95	75

From step size 12.5 or 25	To step size 5, 10, 15, or 20
<i>Frequencies</i>	<i>Display as</i>
0	0
12.5	10
25	20
37.5	30
50	50
62.5	60
75	70
87.5	80

5 Programmable VFO Tuning Limits

This radio provides the capability of programming the VFO tuning range, in 1 MHz band segments, as well as providing a separate programmable band scan function. (See page 26)

For example you could tell the transceiver that you only wish to tune the 144.000 MHz and 145.000 MHz band segment by specifying any frequency within these two segments.

The Tuning controls would then only tune within these specific bands. The procedure for specifying the bands is described below.

- 1 Select the desired lower tuning limit.
For example you might want to select the 144 MHz band and dial up 144.100 MHz.
- 2 Press and hold the M key for longer than one second, then press the 1 key. This selects the lower frequency limit for the programmable VFO.
- 3 Select the desired upper tuning limit.
For example you might want to select the 145 MHz band and dial up 145.100 MHz.
- 4 Press and hold the M key for longer than one second, then press the 2 key. This selects the upper frequency limit for the programmable VFO.

- 5 To confirm that the programming was properly performed rotate the Tuning control. The transceiver should not go above or below the programmed band limits.

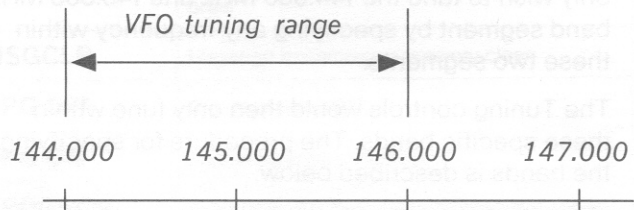

To clear the programmed limits simultaneously reset the VFO memory using the procedures discussed on page 19.

You can reprogram either limit independently by following the appropriate instructions above.

6 Basic Receiving Functions

When receiving a signal, the Main/Sub S-meter deflects and the Main/Sub BUSY indicators appear.

Rotate the volume control to the desired level.

Note

For information about more advanced receiving capabilities, see *Enhanced Receiver Function* on page 48

TRANSMITTER OPERATION

WARNING:

Before you attempt to transmit, attach an antenna with a low standing wave ratio to the antenna connector. Failure to provide a proper load may cause damage to the final amplifier section. Always check that the frequency is clear before transmitting.

1 To transmit, follow these steps:

- 1 Use any of the frequency selection methods discussed on page 12 to select an operating frequency.
- 2 Listen to the frequency to see if it's occupied before attempting to transmit on it.
- 3 Press the PTT (Press to talk) switch. The ON AIR indicator and battery level meter will appear.

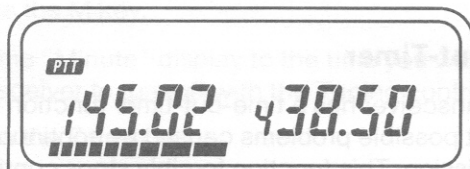

- 4 Speak into the microphone from the recommended distance of 5 cm (2 inches). Talking closer or farther away can result in loss of clarity, an excessively wide transmit signal, or weak audio.
- 5 Release the PTT switch to return to the receive mode. The ON AIR and battery level meter indicators should go out.

2 Changing Transmitter Output Power

Press the F key, then the D/LOW key to select three different transmitter output power levels. Repeat this function to stop through the power level selections. The actual transmitter output power for this unit depends on the power supply used. Indicators will appear on the display to tell you which level you have selected.

You can select the transmitter output for both the VHF and the UHF band.

The "E and L" indicators show the Economic Low power position. Use Economic Low power for line-of-sight short-distance communication.

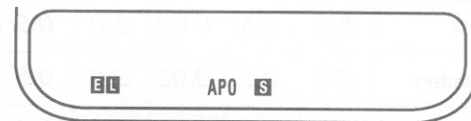

The "L" indicators shows the Low power position. Use Low power for short-distance communication.

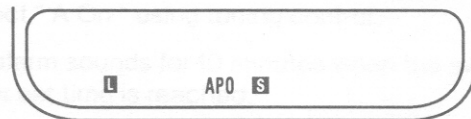

No indicator means the high power position has been selected. Use high power for maximum transmitter power.

See the high power CAUTION on page 5.

Output Power(watts)

(Approx.)

	144MHz			430/440MHz		
	H	L	EL	H	L	EL
PB-13, 18	2.0	0.5	0.02	2.0	0.5	0.01
PB-14, 17	5.0	0.5	0.02	5.0	0.5	0.01
Alkaline Battery	2.0	0.5	0.02	2.0	0.5	0.01
External Power Supply (13.8V DC)	5.0	0.5	0.02	5.0	0.5	0.01

3 TX. Stop Function

The TX Stop function allows you to temporarily disable the transceiver transmit, preventing accidental or unauthorized transmission.

Press the F key, then press the f²/TX.S key to turn the TX. Stop function on or off.

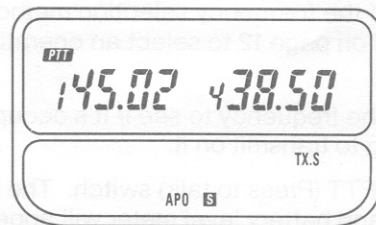

4 Time-Out-Timer

This transceiver has a time-out-timer function to prevent possible problems caused by continuous transmission. This function forcibly stops continuous transmission after 10 minutes. When the timer times out, the transceiver beeps and automatically returns to the RX mode. Press the PTT switch to transmit again.

The time-out-timer function cannot be turned on or off.

USING THE MEMORY

1 Microprocessor Memory Backup

All memory channel data is backed up in EEPROM. It is not lost unless you reset the memory.

All other data that you set is retained by a secondary lithium battery that will provide memory backup for about 20 days if you remove the battery pack or external DC power.

A fully discharged battery will require approximately 10 hours to reach full charge after installing a NiCd battery pack or external power.

2 Initializing The Memory

Press and hold the M key and turn on the power to reset the memory. All the LCD indicators will appear on the display. Release the M key. This resets all user programmed data to the factory defaults.

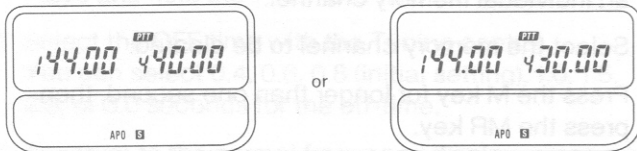

Factory Default Settings

	144 MHz Band	440/430 MHz Band
VFO Frequency	144 MHz	440/430 MHz
Call Channel Frequency	144 MHz	440/430 MHz
Frequency Step	5 kHz/12.5kHz	25 kHz
Tone Frequency	88.5 Hz/1750 Hz	88.5 Hz/1750 Hz

VFO Reset

Press and hold the F key and turn on the POWER switch to reset the microprocessor's VFO memory, without destroying the memory channel, CLOCK data, message memory data, automatic dialer DTMF memory, Programmable SCAN tuning range, PAGING code, or CALL channel data.

3 Memory Channel

This transceiver provides 50 memory channels. In addition to serving as a normal memory channel Memory Channel 1 is used to store the frequency for the Priority Alert function.

4 Memory Contents

Each memory channel can store information as shown in the chart below.

× = Can be stored in memory

	<i>Normal Channel</i>	<i>Split Channel</i>
RX frequency	×	×
TX frequency	<i>N/A</i>	×
Tone(CTCSS) frequency, Tone (CTCSS) status	×	×
Frequency step	×	×
Shift status, REV on/off	×	<i>N/A</i>
DTSS code, DTSS status	×	×

5 Entering Memory Data

Entering memory data is a simple operation requiring just a few keystrokes to store all the data you require.

Entering Normal Simplex/Repeater Channels

- 1 Select the desired receive frequency, offset, and any other information you desire. If the desired frequency is already on the display, continue to step 2.

- 2 Press the M key. The memory indicator will flash.

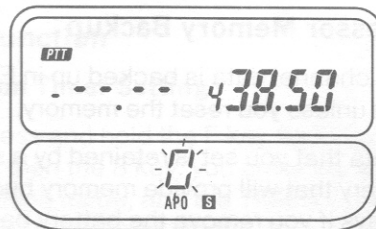

- 3 Use the keypad to select any desired memory channel number (0~49). Use a two-digit number, such as 02 for channel 2 or 15 for channel 15, to enter the data in memory.
- 4 Press the MR key.
- 5 The memory channel number will turn off, indicating that the receiver data has been properly stored.

Clearing a Memory Channel

Use the following procedure to clear the contents of an individual memory channel:

- 1 Select the memory channel to be cleared.
- 2 Press the M key for longer than one second, then press the MR key.
- 3 The selected memory channel number is removed from the display and the data is cleared from the memory.

6 Entering Split Channel Frequencies

- 1 Use the numeric keypad to select the desired receiver frequency, tone and other information. If the desired frequency is already on the display, continue to step 2.
- 2 Press the M key. The memory indicator will flash.
- 3 Use the keypad to select any desired memory channel number (0~49). For example, use a two digit number, such as 02 for channel 2, or 15 for channel 15, to enter data in memory.
- 4 Press the MR key.
- 5 The memory channel number will turn off, indicating that the receiver data has been properly stored.
- 6 Use the numeric keys to enter the desired transmit frequency.
- 7 Press the M key. The memory channel indicator will flash.
- 8 Press and hold the PTT switch and then press the MR key.
- 9 The TX frequency is set. The system returns to its previous state.

Note

You will hear an error sound if you attempt to recall a memory when nothing is stored in that memory.

Confirming the Contents of the Split Channel

- 1 Press the MR key. The programmed receiver frequency appears on the display with “+” and “-” offset direction indicators showing that this channel has an odd split entered.

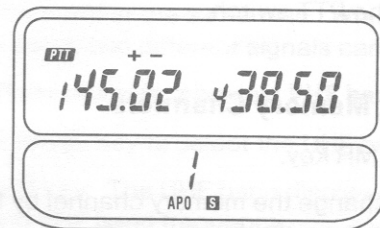

- 2 Press the F key, then press the SHIFT/REV key, or just the PTT switch, to check the transmit frequency. The transmit frequency will appear on the display.

7 Entering The Call Channel Frequency

- 1 Use the numeric keypad to select the desired receiver frequency, tone and other information.
- 2 Press the M key, then press the CALL key within 10 seconds. You have now entered the call channel frequency.

If entering an odd split channel, continue with steps 3 to 6.

- 3 Select the desired call channel transmit frequency.
- 4 Press the M key.
- 5 Press and hold the PTT switch and press the CALL key.
- 6 Release the PTT switch.

8 Recalling Memory Channels

Press the MR key.

You can change the memory channel by the following two methods.

Using the Tuning Control

Rotate the tuning control clockwise or counterclockwise to select the desired Memory Channel.

Using the numeric keypad

Select any desired memory channel number (0~49). For example, use a two digit number, such as 02 for channel 2, or 15 for channel 15.

If you install the optional ME-1, you cannot recall more than 100 memory channels in the two digits recall mode (initial states).

You must change the function to three digit recall mode.

- 1 Press and hold the MR key and turn the power on. The VHF band frequency display changes to the recall selection mode with the numeric keys.
- 2 Select —3 with the right encoder.
- 3 Press any front panel key to return to the normal frequency display.

9 Memory Shift

Press the F key, then press the VFO key to copy the contents of a memory or call channel to the VFO without changing the data in memory. Doing this allows you to begin tuning at the point specified by the memory channel data.

Caution

You cannot perform memory shift if the displayed frequency exceeds the programmable VFO setting range (see page 15).

10 Memory Channel Character Display

You can display the memory channel frequency with your own spelling. It may be up to six characters long. You can use numerics 0 to 9 and the letters A to Z.

Function Setting

Press and hold the f^2 key, and turn the power on.

Note

When you select this function, the memory channel can be displayed alphanumerically, but the total number of available memory channels is halved, i. e., 25.

To return to 50 channels, repeat the operation.

Character registration

- 1 Press the MR key to enter the memory channel mode.
- 2 Select a desired channel from among the memory channels in which you stored data using the Tuning control or numeric keypad.
- 3 Press the M key, then press the f^2 key to enter the message setting mode.

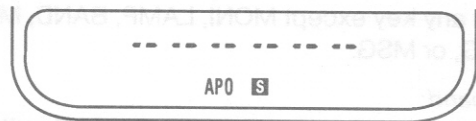

- 4 Enter your message with the keypad. See the list on page 45 for the key combinations for each letter.
- 5 If you enter the wrong message, press the VFO key to start over step 4.
- 6 Press the MR key at the end.
- 7 You can display a message from other memory channel by performing steps 2 to 6 again.

Note

A message can be displayed for a maximum of 25 memory channels.

If a message is specified for a memory channel, the message is displayed instead of the memory channel number.

If you want to display the memory channel number, press and hold the F key for longer than one second, then press the f^2 key.

Message Display Cancel

- 1 Select the memory channel to be canceled.
- 2 Press and hold the M key for longer than one second, then press the f^2 key.

The message display is canceled, and the memory channel is displayed.

SCANNING

You must adjust the squelch to the threshold point for proper scan operation. You cannot use scan in conjunction with the tone alert function and paging. Scanning occurs separately in the VHF and UHF bands.

You can reverse the direction by turning the Tuning control or MESSAGE key.

1 Hold/Resume Programming

This transceiver provides two types of scan hold/resume:

■ Time Operated Scan

The transceiver stops scanning on a busy channel, remains there for approximately 5 seconds, and then continues to scan even if the signal is still present.

■ Carrier Operated Scan

The transceiver stops scanning on a busy channel and remains there until the signal drops out. It allows a 2 second delay before resuming scanning to prevent losing the station when operators change.

In CTCSS operation, scan will stop only on signals that contain the proper CTCSS code.

In DTSS operation, scan will stop (without squelch turned off) whenever it receives a signal. However, squelch will not open until the proper DTSS signal is received.

In combined CTCSS and DTSS modes, scanning stops when the proper CTCSS tone is received. Squelch will open only if the DTSS signal matches when the scan stops.

Hold/Resume Selection

The transceiver is delivered from the factory in the Time Operated Scan mode. Use the following procedure to switch between modes:

■ VHF Band :

Press and hold the 8 key and turn on the power.

■ UHF Band:

Press and hold the 9 key and turn on the power.

2 Scan operation cancel

Operation band:

Press any key except MONI, LAMP, BAND, MHz, E.CHG, or MSG.

Sub-band:

Press the BAND key, then press the PTT switch.

3 Scan Options

The following scan options are available:

■ Memory Scan

Scans through those memory channels that have data stored and that have not been locked out. This function operates only in the memory mode.

■ Band Scan

Scan proceeds over the entire band. This function operates only in the VFO mode. (page 26)

■ Programmable Band Scan

The scan range for this mode is specified in memory. (page 26)

■ MHz Scan

Scans over a 1 MHz range. (page 27)

■ VFO / Memory Scan

Provides alternate scanning of the VFO and last used memory channel. (page 27)

■ CALL/VFO Scan

Provides alternate scanning of the call channel and the VFO. (page 28)

■ CALL / Memory Scan

Provides alternate scanning of the call channel and last used memory channel. (page 28)

■ V/M/C(VFO/Memory/CALL) Scan

Scans the VFO, the last memory channel used, and the call channel. (page 28)

4 Scanning Memory Channels

Note

The transceiver scans only those memory channels that have data entered and are not locked out. Scanning does not start unless two channels or more have data entered.

- 1 Adjust the SQL control to the threshold point.
- 2 Press the MR key.
- 3 Press and hold the MR key for longer than one second. The MHz indicator (decimal) flashes when the transceiver is scanning.

Locking Out Memory Channels

This function allows you to specify which memory channels you want to skip during memory channel scan.

- 1 Select the appropriate numbers of the memory channels that you want to skip.

- 2 Press the F key, then the 0/L.OUT key.
A ★ indicator appears below the memory channel number on the display, indicating that channel will be skipped in the memory channel scan mode.

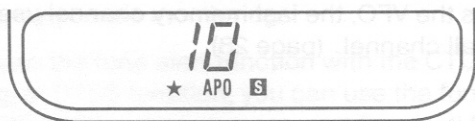

- 3 Repeat steps 1 and 2 to lockout any other channels you may want to skip.
- 4 To cancel the lockout, select the memory channel number. If it was locked out, it will have the ★ indicator on the display.
Press the F key and then the 0/L.OUT key. The ★ will disappear.

5 Band scan

- 1 Adjust the SQL control to the threshold point.
- 2 Press the Band key to select the desired Scanning Band.
- 3 Press the VFO key to select the VFO mode.
- 4 Press and hold the VFO key for longer than one second.

Scanning begins toward the higher frequencies. The MHz indicator (decimal) flashes when the transceiver is scanning.

- 5 Scanning pauses on a station strong enough to open the squelch and turn the BUSY indicator on.

6 Programmable Band Scan

This transceiver can select and scan a frequency range in a band.

You can set separate limits for both VHF and UHF, limiting dual scan on both bands.

Even if you sets the programmable band scan limits, the VFO tuning range is not limited unlike the programmable VFO function. (See page 15.)

For example, you can program so that the transceiver scans a range from 144.50 to 145.80 in the VHF band.

Use the following procedure to specify the desired scan limit.

- 1 Press the BAND key to select the desired Band.
- 2 Select the desired upper scan limit.
- 3 Press and hold the M key for longer than one second, then press the 5 key.
- 4 Select the desired lower scan limit.

- 5 Press and hold the M key for longer than one second, then press the 4 key.

Notes

- 1 Initialize the VFO memory (VFO RESET) to clear both programmed limits simultaneously. Press and hold the F key and turn on the power. You can reprogram either limit independently.
- 2 Programmable band scan is not initiated when the lower frequency limit is not in the same band or step size, or when it is higher than the upper limit frequency.

Confirming Scan Limit

- Press the F key for longer than one second, then press the 4 key to display the band scan lower frequency limit.
- Press the F key for longer than one second, then press the 5 key to display the band scan upper frequency limit.

Initiating Programmable Band Scan

- 1 Adjust the SQL control to the threshold point.
- 2 Select a frequency between the two programmed scan limits.
- 3 Press and hold the VFO key for longer than one second.

The MHz indicator will flash when the transceiver is scanning.

7 MHz Scan

- 1 Adjust the SQL control to the threshold point.
- 2 Start the band scan or programmable band scan.
- 3 Press the MHz key during band scan or programmable band scan. Scanning begins in an upward sequence over a 1 MHz range.

Example: If the MHz key is pressed when the frequency is 145.02 MHz for VHF band scan, just the 145 MHz band is scanned.

8 VFO/Memory Scan

This function lets you alternately scan the VFO frequency shown on the display and the last-used memory channel.

- 1 Adjust the SQL control to the threshold point.

- 2 Press the F key, then press the MR key.
- 3 The VFO frequency and the last used memory channel are scanned alternately.

9 CALL/VFO Scan

- 1 Press and hold the CALL key for longer than one second in VFO mode.
- 2 The frequency and CALL frequency are scanned alternately.

10 CALL / Memory Scan

- 1 Press and hold the CALL key for longer than one second in memory channel mode.
- 2 The memory channel in use and CALL frequency are scanned alternately.

11 V/M/C(VFO/Memory/CALL) Scan (except European version)

- 1 Press the F key, then press the CALL key.
- 2 The VFO frequency, last used memory channel, and CALL frequency are scanned alternately.

12 The Alert Function

This function allows you to monitor memory channel 1 for activity once every 5 seconds, even when you are tuned to a different frequency.

- 1 Enter the frequency you wish to monitor in memory channel 1.
- 2 Adjust the SQL control to the threshold point.
- 3 Press the F key, then press the 4 key. The AL indicator displays.
- 4 A beep will sound when a signal is present.
- 5 Press the F key and the 4 key again to turn this function off. The AL indicator will disappear from the display.

When using the Alert function, be aware that:

- Channel 1 CTCSS programming is ignored.
- You will not hear voice communication while scanning memory channel 1, only a beep if a signal is present.
- Memory channel 1 is also monitored when the dual band and single band are displayed.

REPEATER OPERATION

1 Transmitter Offsets

All amateur radio repeaters use a separate receive and transmit frequency. The receive frequency may be above or below the transmit frequency. Most repeater configurations fall into one of the following categories.

Offset Direction	VHF Band	UHF Band	UHF Band (European version only)
+	+ 600 kHz	+ 5 MHz	+ 1.6 MHz
-	- 600 kHz	- 5 MHz	- 1.6 MHz
--			- 7.6 MHz

2 Selecting the Offset Direction

Press the SHIFT key. The transceiver will shift from one offset direction to the other, such as from + to -, or from - to simplex where no indicator shows. In the European version (UHF band), - change to --.

3 Automatic Offset Selection

■ U.S.A. and CANADA versions

The TH-78A is programmed according to the standard ARRL (Amateur Radio Relay League) Band Plan for repeater offset direction. You can override this programming by using the SHIFT key as described in the preceding paragraph.

■ European version

The TH-78E automatic offset is programmed as follows.

144.00 145.600 145.800

SIMPLEX	- 600 kHz	SIMPLEX
---------	-----------	---------

■ To cancel automatic offset

Press and hold the BAND key and switch the power on.

This operation switches automatic offset mode on or off.

4 Manual Offset Selection

The factory default sets the automatic offset frequency. You can select any offset frequency in the range 0 to 99.9 MHz in 100 kHz steps.

- 1 Press and hold the SHIFT/REV key and switch the power on.
- 2 Press the F key for longer than one second, then press the SHIFT/REV key.
The current offset frequency is shown on the LCD.
- 3 Rotate the Tuning control, and select the desired offset frequency.
- 4 Press any front panel key to return to the normal frequency display.

To return to the normal offset, reset the VFO.
(see page 19)

Note

Selecting an offset frequency that would result in the radio transmitting outside its intended range will cause an error tone to be sounded and transmit to be inhibited. Reselect a valid offset frequency if this occurs.

5 The Reverse Function

Some repeaters use a 'reverse pair', that is, the transmit/receive frequencies are the reverse of other repeaters.

For example, repeater A uses 146.000 as an input frequency, and 146.600 as an output frequency. Repeater B might use 146.600 as an input frequency, and 146.000 as an output frequency. It would be quite inconvenient to have to reprogram the transceiver each time you want to use these repeaters.

Press the F key, then press the SHIFT/REV key. The R indicator displays to remind you that you are working a reverse pair.

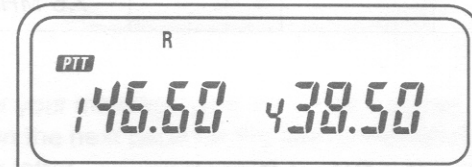

Press the F key, then press the SHIFT/REV key again to return to normal. The R indicator will disappear.

This function is also useful in checking the repeater input frequency, allowing you to determine if you are in range for simplex communication.

6 Tone Operation

Some repeaters require a control signal to activate them. Several different methods are currently in use.

In the United States, sub-audible tones are sometimes used. This transceiver will generate sub-audible frequencies.

In Europe and the United Kingdom, a 1750 Hz tone is used in transmitting. Simply press and hold the TONE key to transmit the access code. You need not press the PTT switch. A 1750 Hz tone encoder is included with models delivered to Europe and the United Kingdom.

Selecting Tone Frequencies

If the optional CTCSS unit (TSU-7) is not installed, you cannot change the tone frequency.

- 1 Press the F key for longer than one second, then press the TONE key. The current tone frequency will appear on the display.

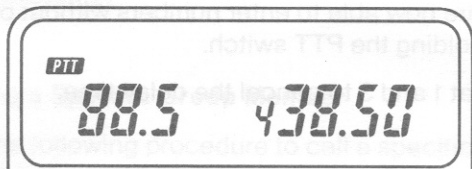

- 2 Rotate the tuning control to select the desired tone frequency(Hz)

(Hz)	(Hz)	(Hz)	(Hz)	(Hz)	(Hz)	(Hz)	(Hz)
67.0	82.5	97.4	114.8	136.5	162.2	192.8	233.6
71.9	85.4	100.0	118.8	141.3	167.9	203.5	241.8
74.4	88.5	103.5	123.0	146.2	173.8	210.7	250.3
77.0	91.5	107.2	127.3	151.4	179.9	218.1	1750
79.7	94.8	110.9	131.8	156.7	186.2	225.7	

- 3 Press any key or simply wait 10 seconds for the transceiver to resume the previous mode.

Tone Function Operating

Press the TONE key. A " T " indicator appears on the display, and the transmitter sends the desired tone when you press the PTT switch.

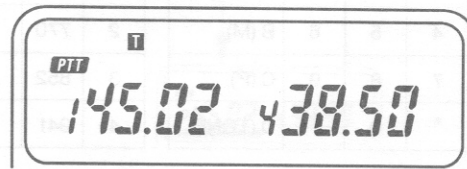

7 Autopatch Operations

(U.S.A. versions only)

Some repeaters offer a service called autopatch. This feature allows you to dial a telephone number from your transceiver and carry on a telephone conversation.

This function requires the use of a DTMF (Dual Tone Multi Frequency) keypad. The transceiver also provides four additional keys - A, B, C, and D - in addition to the normal 12 keys found on your telephone.

These keys are required for various control operations by some repeater systems. A chart listing the various tone frequencies generated by the keypad is provided below.

Hz	1209	1336	1477	1633	key	Hz	key	Hz
697	1	2	3	A (F)	1	697	5	1209
770	4	5	6	B (M)	2	770	6	1336
852	7	8	9	C (f ²)	3	852	7	1477
941	*	0	#	D (TONE)	4	941	8	1633

To activate the keypad:

Press and hold the PTT switch

Dial the number just as you would on a normal telephone by pressing the appropriate keys.

Note

Some repeaters require a special key sequence to activate the autopatch function. Check with the control operator for this sequence.

You will hear and transmit a single tone if you press the VFO key before pressing one of the numeric keys (see the chart at right).

Selecting Delay Time

(Direct keyboard entry only)

It's easier to enter a long string of numbers if you don't have to hold down the PTT switch while you enter them. To instruct the transceiver to remain keyed for 2 seconds after pressing each number:

- 1 Turn the power off.
- 2 Press and hold the 2 key and turn on the power.
- 3 Release the 2 key.

You are now able to enter numbers without pressing and holding the PTT switch.

Repeat 1 and 3 to cancel the delay time.

8 DTMF Memory

You can store 10 DTMF telephone numbers up to a maximum of 15 digits long in memory.

Storing DTMF Codes

- 1 Press the M key, then press the MHz key to select the DTMF code entry mode.

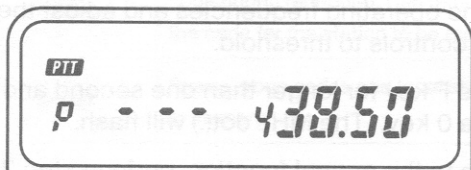

- 2 Enter the DTMF code on the keypad

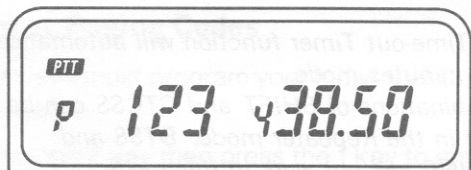

- 3 Press the MR key after entering the DTMF code.

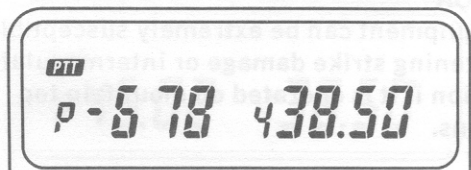

- 4 Select the channel (0~9) where you want to store the DTMF code and press the key for that channel. The DTMF code is stored and the previously displayed frequency reappears.
- 5 If you enter the wrong number, press the VFO key to start over from step 1.
- 6 To stop during entry, press the BAND key. The previously displayed frequency appears on the display.

Recalling Stored DTMF Codes in Receive Mode

- 1 Press and hold the F key for longer than one second, then press the MHz key.
- 2 Press a number key (0~9). The corresponding stored DTMF code is displayed.

Making a DTMF Call

- 1 Hold the PTT switch down and press the MHz key.
- 2 Press the numeric key (0~9) for the channel where the DTMF code is stored.
- 3 The DTMF code appears on the display.

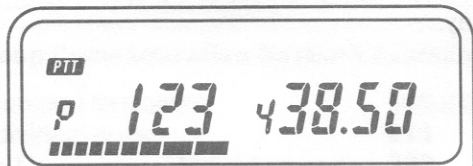

Note

Transmission continues until the whole code string is recalled, even if the PTT switch is released. You cannot stop DTMF code transmission once it is initiated.

OPERATION AS A REPEATER

(U.S.A., CANADA versions only)

This transceiver is capable of operating as a repeater. The transceiver listens on both bands simultaneously. As soon as a signal is received on one band, the other shifts from receive to transmit and re-transmits the incoming signal.

Function setting

- 1 Select the operating frequencies and adjust the squelch controls to threshold.
- 2 Press the F key for longer than one second and then press the 0 key. The MHz dot(.) will flash.

To return to the normal function, perform step 2 again.

Notes

- 1 The Time-out Timer function will automatically set to 3 minutes mode.
- 2 Combinations of SHIFT and CTCSS can be used in the Repeater mode. DTSS and PAGING will not work in this mode.

CAUTION

This equipment can be extremely susceptible to lightning strike damage or intermodulation distortion if it is operated on mountain top locations.

CTCSS OPERATION

The CTCSS unit (TSU-7) is included only with models delivered to the United States and Canada. The CTCSS unit (TSU-7) installation instructions are shown on page 63.

If the Continuous Tone Code Squelch System (CTCSS) function is activated, the transceiver will not open squelch until it receives the proper PL tone (tone squelch).

Selecting Tone Frequencies

You can select the desired tone frequency according to the procedure on page 31.

Operating the CTCSS Function

- 1 Press the BAND key to select the desired band.
- 2 Press the F key, then press the 3 key. The CT indicator will appear on the display.

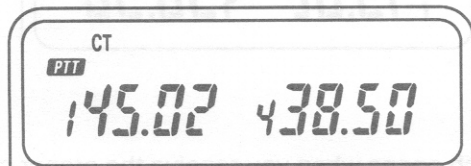

The desired band will now operate in the Tone Squelch mode. That is, squelch will not open until the selected tone is received as a portion of the incoming signal.

If you want to set the CTCSS function to another band, repeat steps 1 and 2.

Note

In duplex operation, if CTCSS is activated in the Sub and Main bands it is not active during transmission.

THE DUAL TONE SQUELCH SYSTEM (DTSS)

DTSS allows squelch activation in the receive mode when the transceiver receives a three-digit code matching the DTSS code you have selected.

Once squelch is activated, it operates normally from then on. If no signal is received for more than two seconds, squelch turns off until the transceiver receives a matching code.

Note

This function is not available in some market areas.

1 DTSS Code

You can select DTSS codes from 000 to 999 in the VFO mode. Store them either in memory channel or in the call channel.

Selecting DTSS Codes

- 1 Press the BAND key to select the desired band.
- 2 Press and hold the F key for longer than one second, then press the 2/DTSS key.

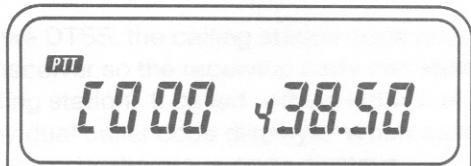

- 3 Enter a three-digit number on the keypad.

Note

Pressing a non-numeric key cancels code selection mode. Code selection cancels automatically if you make no entries within 10 seconds.

2 Using the DTSS Function

- 1 Adjust the squelch to the threshold point.
- 2 Press the BAND key to select the desired band.
- 3 Press the F key, then press the 2/DTSS key. The DT indicator will appear on the display.

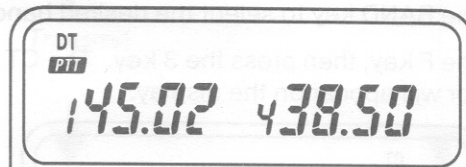

- 4 Squelch opens when you receive the proper code.

- 5 To transmit, press the PTT switch. The DTSS code is sent for about 0.5 second.

Note

Voice output is muted during code output. We recommend that you turn off the battery saver function when you use DTSS.

- 6 Press the F key, then press the 2 key to cancel the DTSS function.

Note

Although you can select the CTCSS function simultaneously in both band, an incoming DTSS code may be lost at certain timings.

3 Using DTSS with a Repeater

Pressing the PTT switch transmits the DTSS signal after a short delay. The delay helps avoid any malfunction that might be caused when the repeaters switching times interrupt the DTSS signal.

The normal delay time is 250 milliseconds. When using shift or split channel operation, the delay time is 450 milliseconds.

You can change the delay time to 250 milliseconds.

To Change Delay Time

- 1 Turn the power off.
- 2 Press and hold the 1 key.
- 3 Turn the power on.
- 4 Release the 1 key.

PAGING

Paging uses a DTMF (Dual Tone Multi Frequency) signal and is useful in calling members of a group, a specific station, or for waiting for a call from another station.

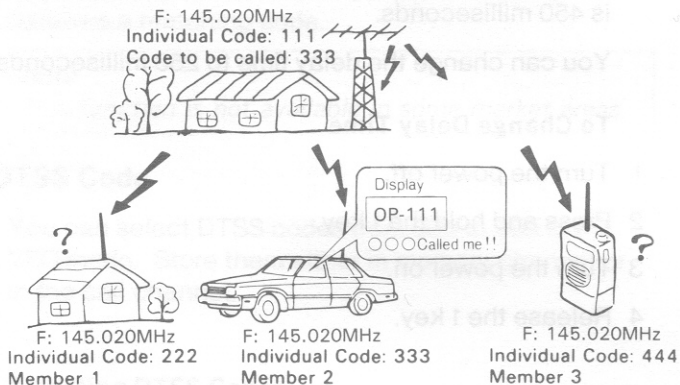

You should determine the common group paging code and individual codes in advance. You can enter three-digit codes from 000 to 999.

Unlike DTSS, the calling station code displays on the transceiver so the receiving party can identify the calling station. If called with an individual code, the individual caller code displays. When called with a group code, the group code displays.

1 Paging Operation Overview

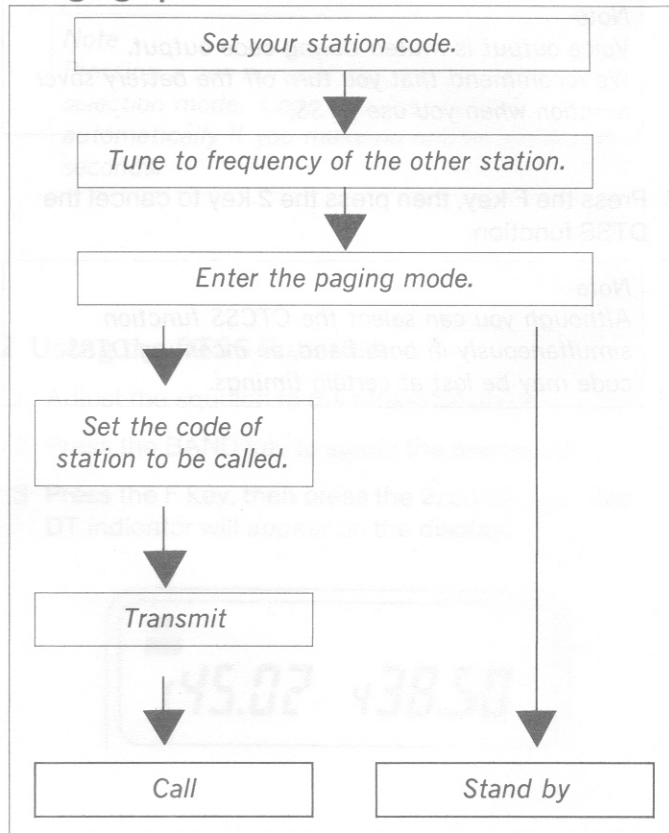

2 Paging Code Memory

There are 8 paging code memories.

Memory Code Use

A	Stores your station ID code in memory.
0	Automatically stores the calling station's code during reception. Can temporarily set the code for the station to be called.
1~6	Stores group codes and local station codes in memory.

3 Setting Paging Codes

First, you must program your Individual Code into Memory A.

- 1 Press the F key then press the 1 key to enter the Paging mode.

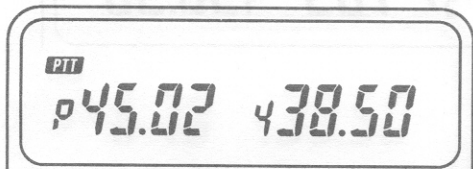

- 2 Press and hold the F key for longer than one second, then press the 1 key to enter the code setting mode.

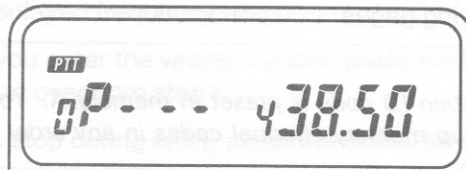

- 3 Rotate the tuning control to select A (your individual code channel).

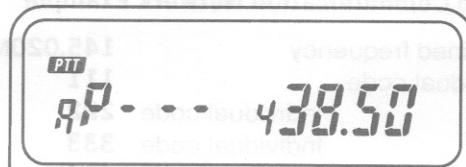

- 4 Enter your individual code (000 to 999) using the numeric keys.

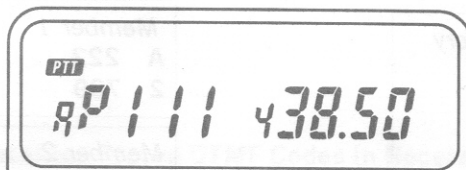

- 5 Your station ID is set in memory A.
- 6 Select 1 to 6 with the tuning control.
- 7 Enter the next Paging Code Memory you wish to program as described in step 4.
- 8 Press any key to exit the code setting mode.

The chart shows how members of a group might communicate with each other. You may wish to refer back to this chart as you read the examples on the following pages.

Note

Your station ID code is preset in memory A. You can set up memory channel codes in any order you wish.

Group Communication Network Example

Predetermined frequency	145.020MHz
Your Individual code	111
Member 1	Individual code 222
Member 2	Individual code 333
Member 3	Individual code 444
Group code	789

Your memory

A **111**
0
1 **222**
2 **333**
3 **444**
4
5 **789**

Member 1

A **222**
2 **789**

Member 2

A **333**
3 **789**

Member 3

A **444**
4 **789**

4 Sending Pages (Calling)

- 1 Turn to the predetermined frequency.
- 2 Press the F key then press the 1 key to enter the Paging mode. The Paging function of the other transceiver must also be on.
- 3 Press and hold the F key for longer than one second, then press the 1 key to enter the code setting mode.
- 4 Use the tuning control to select the memory channel where the local station code is stored

Calling All Group Members

Select the group code memory channel to call all members of a group. In the example below, the group code is stored in channel 5.

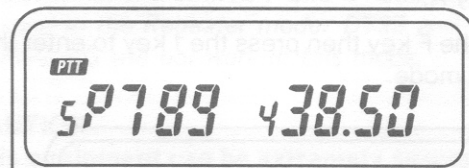

Press the PTT switch. Communication is possible in both the Paging and code setting mode.

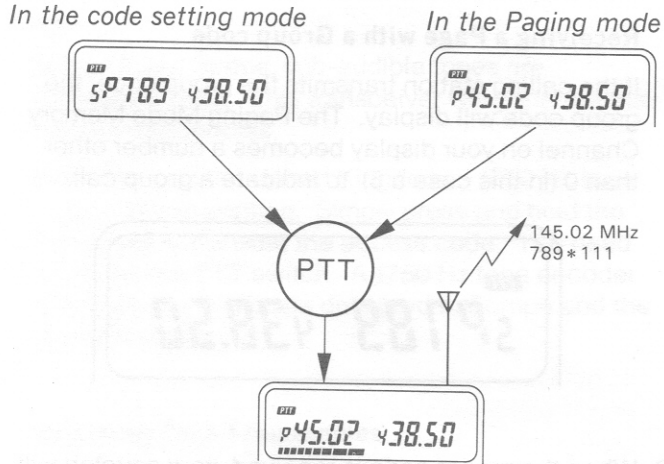

The group code 789 and your station ID code 111 are transmitted.

Calling a Specific Group Member

Use the following procedure to call a specific group member:

- 1 Select the local station code memory. In this example, we have selected memory 3.
- 2 If the local station code is not in memory, enter it in memory 0.
- 3 Press the PTT switch.
- 4 You can cancel Paging once you have established contact.

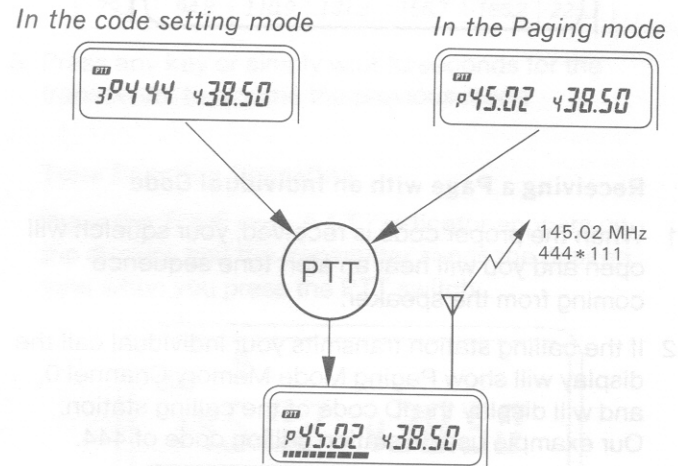

Local station code 444 and your station ID code 111 are transmitted. The DTMF sounds as the codes are transmitted.

5 Receiving Pages (Wait)

- 1 Tune to the predetermined frequency.
- 2 Press the F key then press the 1 key to enter the Paging mode.

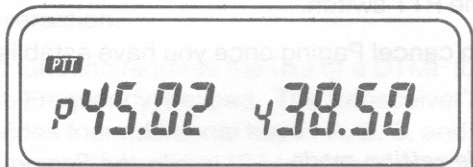

Receiving a Page with an Individual Code

- 1 When the proper code is received, your squelch will open and you will hear an alert tone sequence coming from the speaker.
- 2 If the calling station transmits your individual call the display will show Paging Mode Memory Channel 0, and will display the ID code of the calling station. Our example uses a station calling code of 444.

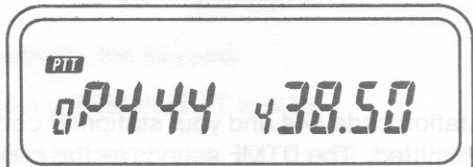

- 3 Press the PTT switch to respond to the calling party.

Receiving a Page with a Group code

- 1 If the calling station transmits the group code, the group code will display. The Paging Mode Memory Channel on your display becomes a number other than 0 (in this case a 5) to indicate a group call.

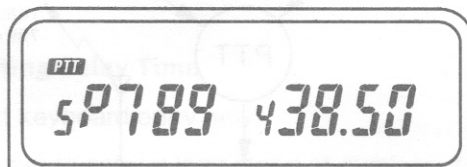

- 2 When the proper code is received, your squelch will open and you will hear an alert tone sequence coming from the speaker.
- 3 Press the PTT switch to respond to the calling party.

Note

An E indicator appears on the display if the local station code cannot be recognized.

Note

You can communicate more efficiently if you cancel Paging after contacting the local station.

6 Canceling Signal Squelch

Squelch will not open when operating in the paging mode when the paging codes do not match. It is possible to reprogram the transceiver so that squelch will open regardless of the incoming page code.

Even when signal squelch is canceled, a beep sounds and the individual code of the local station is displayed when the proper code is received.

Canceling signal type squelch

- 1 Press and hold the F key for longer than one second, then press the CALL key.
- 2 To return signal squelch to the original state, repeat step 1.

7 Locking Out Codes

You can lock a Paging function code only during reception. The Paging code will be transmitted even if it's locked out. The squelch unlocks if an individual code is stored in memories A and 1 through 6 and the codes match.

This remains true even if one local station communicates with another and the code is not locked out. Locking out codes is desirable when you call another group member, but don't want to receive communications between other individuals in the group.

To Lock Out Codes

- 1 Enter the code setting mode (page 39) and use the tuning control to display the memory channel number to be locked out.
- 2 Press the F key, then press the 0 key. The ★ indicator displays and memory locks out.
- 3 To cancel, repeat step 1 and 2.

8 Answer-Back

(U.S.A., CANADA versions only)

If this function has been enabled and you receive a signal with your paging code, the transceiver automatically transmits your code back to the person paging you to receipt of the signal.

This function is used with the Tone alert system.

Function setting

- 1 Press and hold the MHz key, then turn the power on. When you hear the beep, then release the MHz key.
- 2 Press the F key, then press the 5 key to select the Tone alert system.

To return to the normal function, perform step 2 again.

MESSAGE TRANSMISSION AND RECEPTION

This function lets you transmit your message to the other party or display a message from the other party on your transceiver using the DTMF (Dual Tone Multi Frequency) signal and alphanumeric display.

You can use the numerics 0 to 9 and letters A to Z.

The message that can be transmitted and received at one time can be up to six characters long.

Note

This function is used with DTSS or paging.

1 Message Transmission Modes

You can transmit your message by one of the following two methods.

- Transmit your message directly using the DTMF keypad. You must press the # key at the beginning and end of the character.

See the list on the next page for combinations of keys for alphabets.

- Store your message in the message memory, and transmit it.

2 Using the Message Memory.

This transceiver has 10 message memory channels.

Memory write procedure

- 1 Press the M key, then press the MESSAGE key to enter the message setting mode.

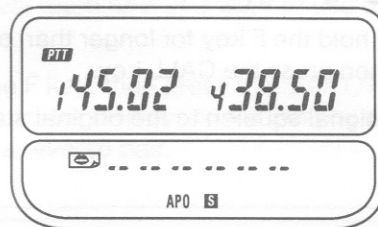

- 2 Enter your message with the DTMF keypad. See the list on the next page for the key combinations for each letter.
- 3 If you enter the wrong message, press the VFO key to start over step 1.
- 4 Press the MR key at the end. The MESSAGE display begins flashing.

Relationship between input characters and keys (Note: “+” means press two keys in sequence (with in 2 seconds))

Input characters	Key operation
0	0
1	1
2	2
3	3
4	4
5	5
6	6
7	7
8	8
9	9

Input characters	Key operation
Q	1+A (F)
A	2+A (F)
D	3+A (F)
G	4+A (F)
J	5+A (F)
M	6+A (F)
P	7+A (F)
T	8+A (F)
W	9+A (F)

Input characters	Key operation
Z	1+B (M)
B	2+B (M)
E	3+B (M)
H	4+B (M)
K	5+B (M)
N	6+B (M)
R	7+B (M)
U	8+B (M)
X	9+B (M)

Input characters	Key operation
(space)	1+C (f ²)
C	2+C (f ²)
F	3+C (f ²)
I	4+C (f ²)
L	5+C (f ²)
O	6+C (f ²)
S	7+C (f ²)
V	8+C (f ²)
Y	9+C (f ²)

For example

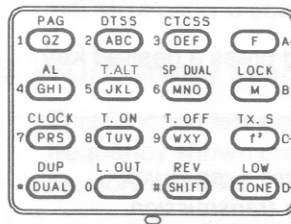
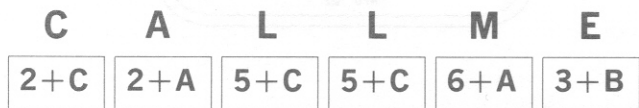

Fixed message

CALLME (Please call me)

FONEME (Please phone me)

ROGER (Roger)

ATHOME (At home)

- 5 Press a key (0 to 9) corresponding to the numeric you want to enter to memory.
- 6 To cancel message input mode, press the PTT switch.

3 Message Memory Check

- 1 Press and hold the F key for longer than one second, then press the MESSAGE key.
- 2 Press a desired key (0 to 9).
- 3 To return to the normal frequency display, press any key (except 0 to 9 key).

4 Message Memory Transmission

- 1 Press the PTT switch, then press the MESSAGE key. The MESSAGE indicator will appear on the display.
- 2 Hold down the PTT switch, and press a desired key (0 to 9).

Note

Message transmission continues even if you release the PTT switch during transmission.

- 3 You can perform steps 1 and 2 any number of times during transmission. Therefore, if you use 10 message memory channels, you can transmit a text of up to 60 characters.

5 Message Reception

- 1 When the DTSS or paging function is on, press the F key, then the MESSAGE key.
- 2 The MESSAGE display lights, and you can now receive a message.

When a message is received, it is displayed, and the MESSAGE indicator flashes.

■ DTSS mode

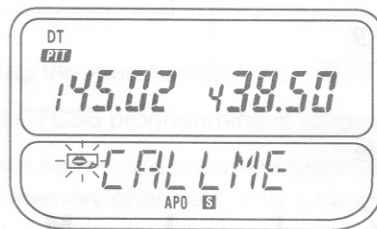

■ Paging mode

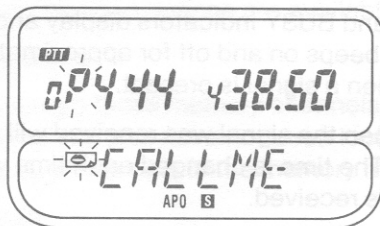

Press any key

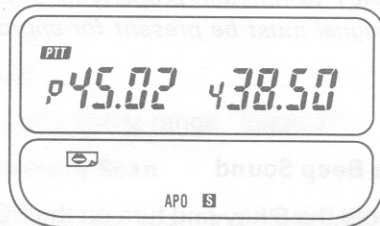

6 Receive Message Memory

This transceiver has 10 incoming message memory channels, in which received messages are stored.

If you press the MESSAGE key in the message mode, the last stored message is displayed.

You can store your message in memory using one of the following two methods. You can select the desired mode.

- If there is data in all 10 message memory channels, new data is written into channel 0 (Factory default).
- If data is stored in all 10 message memory channels, new data is not written into any channel.

Press and hold the MESSAGE key, and switch the power on to change this function.

Receive message memory clear

Press and hold the M key for longer than one second, then press the MESSAGE key.

Note

This operation does not clear the transmit message memory that you set.

ENHANCED RECEIVER FUNCTIONS

1 The Tone Alert System

The Tone Alert function provides an audible alarm to indicate when someone is transmitting on the frequency you are monitoring.

If you use the tone alert function with the CTCSS, paging, or DTSS function, you can use the functional more effectively since you can wait for a call from a specific remote station.

If you set the T.ALT function you will not hear voice communications.

The Automatic Power Off function is disabled during T.ALT operations.

- 1 Press the BAND key to select the desired band.
- 2 Adjust the squelch control to respective threshold.
- 3 Select the desired function if you wish to use it.
- 4 Press the F key, then press the 5 key. The T.ALT indicator will appear on the display.

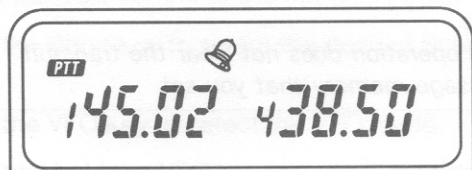

- 5 The T.ALT and BUSY indicators display and the transceiver beeps on and off for approximately 5 seconds when a signal is present.
- 6 The time when the signal was received will be displayed. The time is changed each time when a new signal is received.
- 7 Press the PTT switch to release the T.ALT function.
- 8 Press the F key, then press the 5 key again to completely release the T.ALT function.

Note

For the T.ALT to function properly in CTCSS, the incoming signal must be present for approximately 1 second.

Selecting a Beep Sound

Press and hold the 5 key and turn on the POWER switch to alternate the beep sound between a tone alarm and telephone type ring.

2 Monitor

Even if the squelch or CTCSS, DTSS, or PAGING is ON, you can monitor the channel by pressing the MONI key.

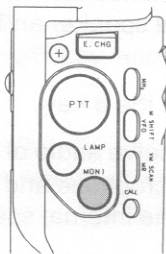

3 Beep Off

The transceiver produces beeps when you push the front panel keys. If you want to disable this function, press and hold the 6 key and press the POWER switch.

4 Lamp

If you press the LAMP key, the LCD illumination lamp lights to help you operate your transceiver at night.

You can use this lamp at any time.

- 1 Press the F key, then press the LAMP key.
- 2 To cancel, press the F key, then press the LAMP key again.

5 Key Lock

Press the F key then press the M key.

The LOCK indicator will appear on the display, and all keys except LAMP, MONI, E.CHG, F+M and PTT, are locked.

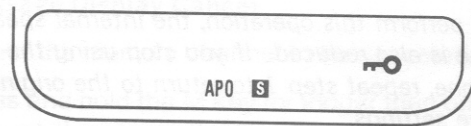

Press the F key then press the M key again to cancel the key Lock function.

6 Volume adjustment when you use an earphone

CAUTION

If you use an earphone, you may feel that the volume is too high even if the volume level is set to minimum. We recommend that before connecting the earphone, you set the volume level to the minimum and perform the following operation to protect your ears.

- 1 Press and hold the 4 key and turn the power switch on.
This operation reduces the volume below the original minimum volume level.
- 2 Minimize the volume levels for both bands.
- 3 Connect your earphone to the External Speaker jack.
- 4 Set the volume to a comfortable level.

Note

If you perform this operation, the internal speaker volume is also reduced. If you stop using the earphone, repeat step 1 to return to the original volume settings.

7 Switching speaker output when a speaker-microphone is connected

If you connect a speaker-microphone to the external speaker jack, you will hear the mixed receive tones of the VHF and UHF bands from the speaker-microphone. These tones can be separated to the transceiver's internal speaker and the speaker-microphone.

- 1 Press the F key then the 6 key.

You will hear the receive audio of the active band from the speaker-microphone and the receive audio of the sub-band from the internal speaker.

- 2 If you want to change the speaker output, press and hold the F key for longer than one second, then press the 6 key.

8 Automatic Band Change Function

The Automatic Band Change function automatically switches transmit control from the RX/TX band to the RX only band whenever a signal is received that opens squelch on the RX only band.

- 1 Press the F key, then press the BAND/A.B.C. key within 10 seconds.

The A B C indicator displays.

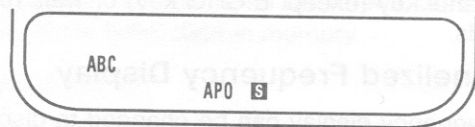

- 2 If a signal comes in on a RX-only band and the BUSY indicator lights, the PTT indicator lights for the receive-only band.
- 3 If you now press the PTT switch, the A.B.C. function turns off, and you can respond to the call from the other party.

Note

When the incoming signal drops out three seconds the PTT indicator will return to the previously selected position.

9 Simultaneous Receive Function of Two Signal in the Same Band

This transceiver has been factory-programmed to receive one VHF signal and one UHF signal at the same time. It is also possible to receive two signals in the same band at the same time. While displaying the same band, two different signals can be selected.

■ To simultaneously receive two VHF band signals

- 1 Press the BAND key to select the UHF band.
- 2 Press the f^2 key. The UHF band display also shows the second VHF band frequency.

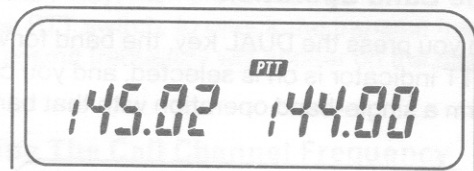

■ To simultaneously receive two UHF band signals

- 1 Press the BAND key to select the VHF band.
- 2 Press the f^2 key. The VHF band display also shows the second UHF band frequency.

Notes on simultaneous in Band reception

- 1 When two signals on the same band are received simultaneously, the receive performance, such as image interference and sensitivity, may be reduced.*
- 2 If the two frequencies are the same, the volume may decrease at some VOL control positions.*

To return to normal operation press the f^2 key again.

10 Single Band Operation

When you press the DUAL key, the band for which the PTT indicator is on is selected, and you can perform a single-band operation with that band.

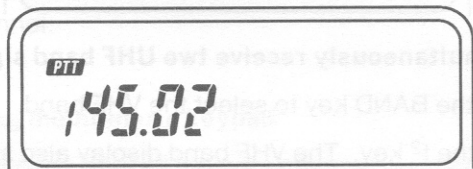

When you press the BAND key, the band in the single-band operation changes.

Each time you press the DUAL key, you toggle between single-band and dual-band operation.

11 MHz Mode

If you use this function, you can change the frequency in 1-MHz steps.

Press the MHz key.

The 100-kHz digit and lower digits of the operation band go blank. When you turn the tuning control, the frequency changes in 1-MHz steps.

To return to the normal frequency display, press any front panel key (except E.CHG key) or wait 10 seconds.

12 Channelized Frequency Display

The frequency display can be changed to display channel numbers instead of the operating frequency. This function makes use of the data you have stored in memory for this function. Channel 1 is memory channel 1, Channel 2 is memory channel 2, etc.

Before attempting to use this function, store frequency data in advance in more than one memory channel for each band.

- 1 Turn the POWER switch off.
- 2 Press and hold down the 3 key, then press the POWER switch.
Channel numbers are displayed for both bands.
- 3 The channel number can be changed with the tuning control.
- 4 To return to the normal frequency display, perform steps 1 and 2 again.

POWER SAVER FEATURES

1 The Battery Saver Mode

This transceiver provides a battery saver mode to conserve on battery power. The battery saver circuit activates 10 seconds after the last key is pressed. The squelch must be closed. This function deactivates whenever a key is pressed or the squelch opens.

The battery saver does not operate during scanning operations.

Press and hold the F key for longer than one second then press the MR key to activate or deactivate the battery saver function.

Battery Save Time Selection

You can change the OFF time when the battery save function is in effect.

- 1 Press and hold the 7 key and turn the power on.
- 2 Select the OFF time with the Tuning control.
You can select 0.4, 0.6, 0.8 (initial setting), 1.0, 1.5, 2.0, or 3.0 seconds for the off-time.
- 3 To return to the normal frequency display, press any front panel key.

2 Automatic Power Off (APO)

- 1 If no signal is received and if you have not performed any operations within 59 minutes, a 5 second audio tone sounds.
- 2 The transceiver switches the power off 1 minute after this tone sounds.

Note

Even through the APO indicator appears on the display, it will not activate during scanning or Tone Alert functions.

- 3 Press and hold the F key for longer than one second, then press the VFO key to turn off the APO function.

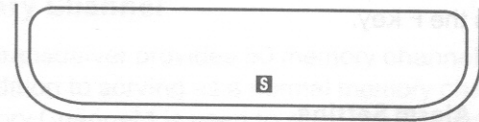

CLOCK FUNCTION

If you press the F key, then the 7 key in receive mode, the clock is displayed on the Sub band display. The time is displayed on a 24-hour basis. If you press the F key, then the 7 key again, the clock is canceled, and the normal frequency display returns.

1 Time Setting

- 1 Press and hold the F key for longer than one second, then the 7 key, the clock is displayed on the Main band display.
- 2 Set the "Hour" display to the current hour with the Tuning control.
- 3 Press the M key.
- 4 Set the "Minute" display to the current minute with the Tuning control.
- 5 Press the F key.

Time Alarm Setting

When you press the 0 key in clock setting mode, the "second" display is cleared, and counting begins from 0 seconds.

2 Timer Function

Switch-on Timer Setting

- 1 If you press and hold the F key for longer than one second, then the 8 key, you enter the switch-ON timer setting mode, and the TIMER.ON indicator and the "Hour" display will flash.

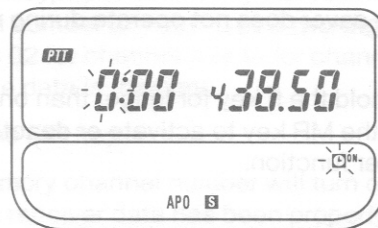

- 2 Set the "Hour" display to the time you want the transceiver to turn on with the Tuning control.
- 3 Press the M key.
- 4 Set the "Minute" display to the time you want the transceiver to turn on with the Tuning control.
- 5 Press the F key.

Switch-off Timer Setting

- 1 If you press and hold the F key for longer than one second, then the 9 key, you enter the switch-off timer setting mode, and the **TIMER.OFF** indicator and the "Hour" display will flash.

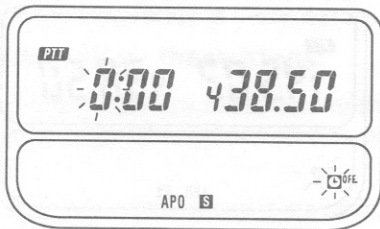

- 2 Set the "Hour" display to the time you want the transceiver to turn off with the Tuning control.
- 3 Press the M key.
- 4 Set the "Minute" display to the time you want the transceiver to turn off with the Tuning control.
- 5 Press the F key.

Timer Start/Stop

If you press the F key, then the 8 key, the switch-on timer starts or stops.

When the switch-on timer starts, the **TIMER.ON** indicator lights on the LCD, and the transceiver is switched on at the set time every day.

If you press the F key, then the 9 key, the switch-off timer starts or stops.

When the switch-off timer starts, the **TIMER.OFF** indicator lights on the LCD, and the transceiver is switched off at the set time every day.

Alarm Function

If you press the M key twice in timer start setting mode, the alarm function setting mode turns on. Select "A On" using tuning control.

An alarm sounds for 10 minutes when the switch-on timer set time is reached.

The alarm stops when you press any front panel key.

DUPLEX OPERATION

Normally this transceiver operates in a simplex mode, i.e. No receive audio from the sub-band is fed to the speaker during transmit on the main or active band.

If you prefer duplex operation, i.e. Receive audio from sub-band is fed to the speaker during transmit you must perform the following procedure.

Press the F key then press the DUAL key. The DUP indicator will appear on the display.

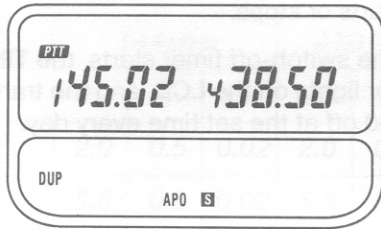

Duplex operation is now possible.

Occasionally the microphone might pick up receive audio, causing howling to occur. To prevent howling in the duplex mode, use an earphone (see page 50) to listen to the receive audio, or perform the following operation.

Press and hold the F key for longer than one second then press the DUAL key. The DUP indicator will flash.

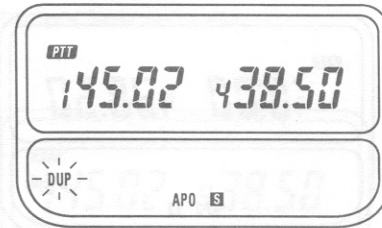

In this mode, the microphone sensitivity and receive audio are reduced automatically to prevent howling. The transmitter output power is also automatically set to the EL position.

You can select the desired transmitter output power by pressing the F key then the D/LOW key.

To cancel this function, repeat the procedure for setting the function. The DUP indicator disappears from the display.

POWER ON MESSAGE AND FUNCTION MESSAGE

1 Power On Message

When you first switch the POWER on, "TH 78A" or "TH 78E" appears on the display for two seconds.

You can change this factory-set message to your own message as follows:

Changing Power-on Message

- 1 Select your message by following steps 1 to 4 of the memory write procedure on page 44.
- 2 Press the 0 key.

The power-on message has now been changed. If you switch the power off and on again, your own message will be displayed on the display for two seconds.

NOTE

The above message, which is stored in message memory channel 0, appears each time you switch the power on.

2 Function Message

When you select a function, the corresponding function message is displayed on the LCD for two seconds.

The message and functions are listed below.

Message	Function
AF CHG	Transpose the two AF bands
AF INI	Initial AF output setting
AF MIX	Mix the AF output from both bands
AF SEP	Separate the AF output into two bands
AS OFF	Automatic offsets OFF
AS ON	Automatic offsets ON
BELL 1	Tone alert (Telephone type ring)
BELL 2	Tone alert (Tone alarm)
BP OFF	Beep OFF
BP ON	Beep ON
DTMF0S	No DTMF signal transmission delay time
DTMF2S	Setting DTMF signal transmission delay time (two seconds)

EAR	Earphone mode
MSG M1	Store receive messages in up to 10 memory channels
MSG MX	If more than 10 messages are received, the oldest message are replaced with the new ones
MSGCLR	Message transmission memory clear
OPG OFF	Signal squelch ON
OPG ON	Canceling signal squelch
PROGSCN	Programmable scan range setting and recall
PROGVFO	Programmable VFO tuning limit setting
SHIFT	Shift width setting mode
SP	External speaker mode
SPLIT	Split memory channel mode

UHF CO	UHF band carrier operate scan mode
UHF TO	UHF band time operate scan mode
VFOCLR	VFO reset
VHF CO	VHF-band carrier operate scan mode
VHF TO	VHF band time operate scan mode
250MS	The delay time for DTMF code transmission is 250 mS
450MS	The delay time for code transmission is 450 mS

MAINTENANCE

1 General Information

Your transceiver has been factory aligned and tested to specification before shipment. Under normal circumstances the transceiver will operate in accordance with these instruction manuals.

All adjustable trimmers and coils in your transceiver has been adjusted at the factory and should only be readjusted by a qualified technician with proper test equipment. Attempting service or alignment without factory authorization can void the transceiver's warranty.

When operated properly, the transceiver will provide many years of service without requiring realignment. The information in this section gives some general service procedures which can be accomplished without sophisticated test equipment.

2 Service

If it ever becomes necessary to return the transceiver to your dealer or service center for repair:

- Pack the equipment in its original box and packing. Do not pack it in crushed news papers. Extensive damage could result during shipment.

- Include a full description of any problems. Include your telephone number.

You need not return accessory items unless they are directly related to the service problem.

Service note

If corresponding on a technical or operational problem, please make your note short, complete, to the point, and legible. Give sufficient detail for diagnosis of the problem. For example, list the test equipment you have available to you, any meter readings you might have taken, and any other information you feel might be useful.

3 Record Keeping

- Record the date of purchase, the unit serial number, and the name of the dealer from whom you purchased the unit.
- Retain a written record of any service or maintenance performed on the unit.

Photocopy the bill of sale or other proof of purchase showing the sale date. This information must be included with the transceiver when claiming warranty service.

TROUBLESHOOTING









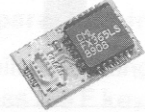

The following problems are generally caused by improper transceiver operation or connection, not by defective components.

If you experience any of these problem causes and corrective actions before requesting service.

<i>Symptom</i>	<i>Probable Cause</i>	<i>Corrective Action</i>
Indicators do not light and no receiver noise is heard when the POWER switch is turned on.	<ol style="list-style-type: none"> 1. Low voltage. 2. With optional DC cable: <ol style="list-style-type: none"> 1) Bad power cable or connections. 2) Blown power supply fuse. 	<ol style="list-style-type: none"> 1. Recharge/ replace the battery. 2. <ol style="list-style-type: none"> 1) Check cables and connections. 2) Check for the cause of the blown fuse and replace the fuse.
No sound from the speaker. No signal can be received.	<ol style="list-style-type: none"> 1. Squelch is closed. 2. With the TSU-7: CTCSS is operating. 3. DTSS is operating. 4. Paging is operating. 	<ol style="list-style-type: none"> 1. Turn the SQL control counterclockwise. 2. Press the F key, then press the 3 key to turn off the CTCSS. 3. Press the F key, then press the 2 key to turn off the DTSS. 4. Press the F key, then press the 1 key to turn off the Paging.
No control works.	<ol style="list-style-type: none"> 1. LOCK is ON. 2. T.ALT is ON. 	<ol style="list-style-type: none"> 1. Press the F key, then press the M key. 2. Press the F key, then press the 5 key.
Memory channel cannot be recalled.	Nothing is stored in the memory channel.	See Using the Memory (page 19)
Memory cannot be backed up.	<ol style="list-style-type: none"> 1. Battery voltage is low. 2. Battery case removed. 	<ol style="list-style-type: none"> 1. Recharge the battery. 2. Install the Battery case.

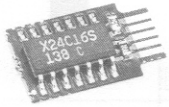
ACCESSORIES

Note: Some optional accessories may not be available in your area.

SPEAKER MICROPHONE		Optional unit	Battery charger
<p>SMC-31</p> 	<p>SMC-34</p> 	<p>TSU-7</p>  <p>(CTCSS unit)</p>	<p>BC-14</p>  <p>(Wall charger)</p>
<p>SMC-32</p> 	<p>HEADSET with VOX/PTT</p> <p>HMC-2</p> 	<p>ME-1</p>  <p>(Memory expansion unit)</p>	<p>BC-15A</p> 
<p>SMC-33</p> 	<p>CLIP MICROPHONE with EAR PHONE</p> <p>EMC-1</p> 		

Batteries		Others	
<p>NiCd BATTERY PACK 7.2 V 700 mAh PB-13</p> 	<p>NiCd BATTERY PACK 12 V 700 mAh PB-17</p> 	<p>DC code PG-3F/3H</p> 	<p>SWIVEL MOUNT BH-6</p> 
<p>NiCd BATTERY PACK 12 V 300 mAh PB-14</p> 	<p>NiCd BATTERY PACK 7.2 V 1100 mAh PB-18</p> 	<p>DC code PG-2W</p> 	<p>Soft case SC-35/36</p> 
<p>BATTERY CASE AA×6 BT-8</p> 		<p>WATER RESISTANT BAG WR-2</p> 	

1 Installing the CTCSS Unit (TSU-7)

- 1 Slide the release button to unlock, then pull out the battery case.
- 2 Unscrew the four screws on the rear (Fig. 1). The screw near the antenna connector is a short one.
- 3 Put your finger into the battery holder, and release the claw of the rear case. (Fig. 2)
- 4 Position the set with its front facing forward.
- 5 Open the front panel from the PTT switch side, being careful of the internal wiring and water resistance rubber attached LEDs. (Fig. 3)
- 6 Remove the jumper wire (J301) using a pair of nippers.
- 7 Attach the TSU-7 to the transceiver, as shown in fig.4.
- 8 Replace the case in its original position, taking care not to pinch any wires or cables under the case.
- 9 Install the four screws.

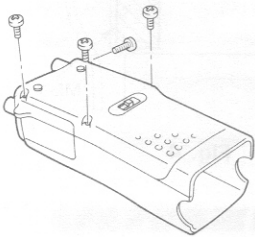

Fig. 1

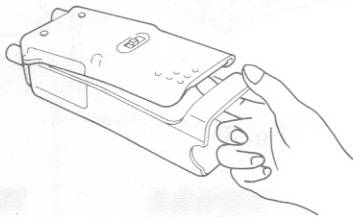

Fig. 2

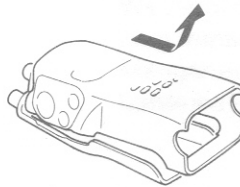

Fig. 3

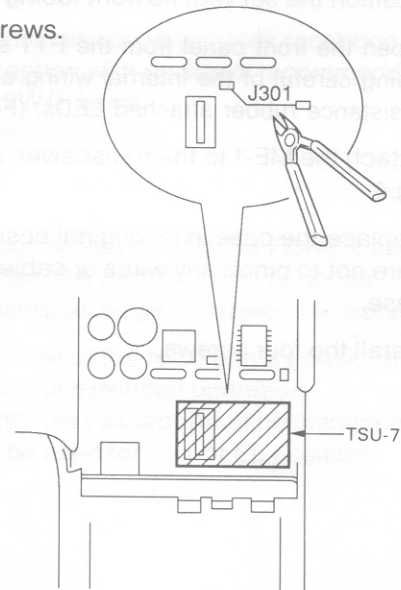

Fig. 4

2 Memory Expansion Unit (ME-1)

- 1 Slide the release button to unlock, then pull out the battery case.
- 2 Unscrew the four screws on the rear (Fig. 1). The screw near the antenna connector is a short one.
- 3 Put your finger into the battery holder, and release the claw of the rear case. (Fig. 2)
- 4 Position the set with its front facing forward.
- 5 Open the front panel from the PTT switch side, being careful of the internal wiring and water resistance rubber attached LEDs. (Fig. 3)
- 6 Attach the ME-1 to the transceiver, as shown in fig.4.
- 7 Replace the case in its original position, taking care not to pinch any wires or cables under the case.
- 8 Install the four screws.

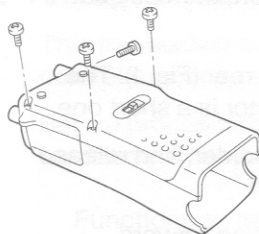

Fig. 1

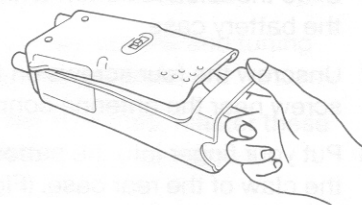

Fig. 2

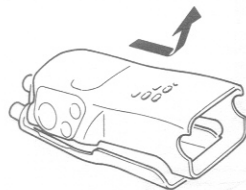

Fig. 3

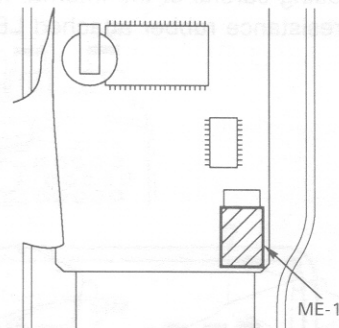
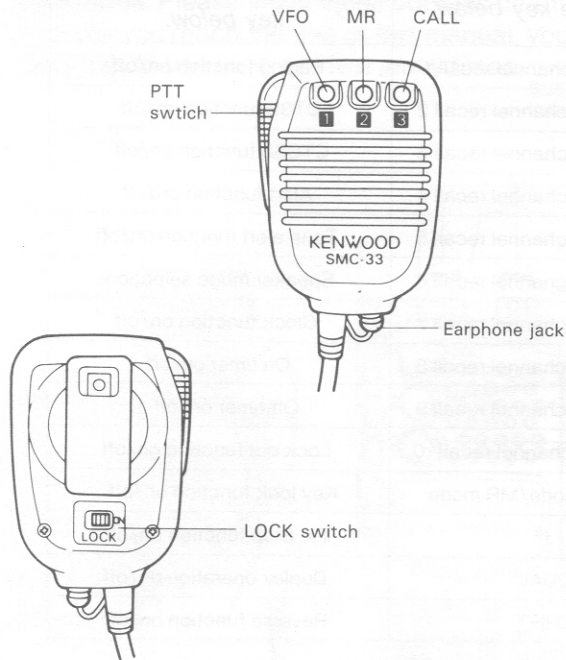

Fig. 4

3 Programming the SMC-33 Remote Control Speaker Microphone



These keys function just like the VFO, MR, and CALL keys on the front panel of the transceiver.

To reset the function of the transceiver keys.

- 1 Connect the SMC-33 to the MIC jack on top of the transceiver.
- 2 Press and hold Microphone key 1 (or 2 or 3) and turn the power on. The programmable function (PF) indicator appears for 10 seconds.

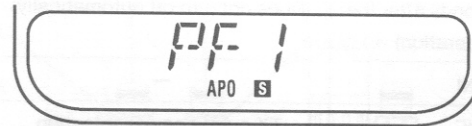

- 3 Press a key on the transceiver - or press F and a key - to assign that key's function to key 1 (or 2 or 3) on the SMC-33. The possible functions for the SMC-33 keys 1, 2, and 3 are listed on the next page.

For example, press the BAND key on the transceiver to make key 1 on the SMC-33 function as the BAND key. Press the F key, then the BAND key to make key 1 function as the A.B.C. key.

Turn the LOCK switch on to disable microphone keys 1, 2, and 3.

You can use the SMC-33 with models that have no remote function for simple transmit and receive function. No remote functions will be possible. Make sure the LOCK switch on the back of the microphone is on before using it with such models.

Memory Control Functions

<i>Press the key below.</i>	<i>Press the F key , then the key below.</i>
Tuning control (*1)	—
(E.CHG) (*2)	Encoder/Volume selecting mode
LAMP (Turns off 5 seconds after the last key operation)	LAMP (Does not turn off automatically)
MONI	—
TONE	TX output power selection
MHz	—
VFO	Memory shift
MR	V/M scan
CALL	V/M/C scan TX. out put power selection(*3)
MESSAGE	Message function on/off
BAND	A.B.C.

- *1. Clockwise rotation sets the UP function, counterclockwise rotation sets the DOWN function.
- *2. Can not the key function.
- *3. UK and European version only.

<i>Press the key below.</i>	<i>Press the F key , then the key below.</i>
1 : Memory channel recall 1	Paging function on/off
2 : Memory channel recall 2	DTSS function on/off
3 : Memory channel recall 3	CTCSS function on/off
4 : Memory channel recall 4	Alert function on/off
5 : Memory channel recall 5	Tone alert function on/off
6 : Memory channel recall 6	Speaker mode selection
7 : Memory channel recall 7	Clock function on/off
8 : Memory channel recall 8	On timer on/off
9 : Memory channel recall 9	Off timer on/off
0 : Memory channel recall 0	Lock out function on/off
(M) VFO mode/MR mode	Key lock function on/off
f ²	TX. Stop function on/off
DUAL	Duplex operation on/off
SHIFT	Reverse function on/off

4 Using Other Microphone

If not using the SMC-33, we recommend using an electret type microphone. The input impedance is 2k ohms and the DC voltage on the microphone terminal is approximately 4 volts (Max. 3.5 mA). Do not use a dynamic microphone.

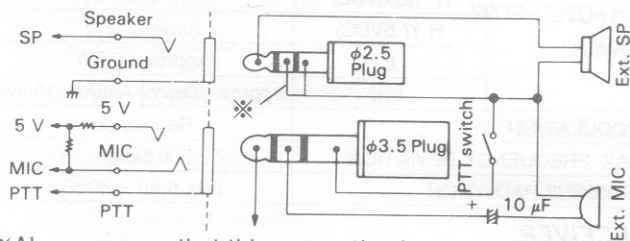

※Always ensure that this connection is made.

SPECIFICATIONS

GENERAL

		144MHz band	440/430MHz band
FREQUENCY RANGE (MHz)	U.S.A. Version	144 to 148	438 to 450
	U.K.and Europe	144 to 146	430 to 440
	Other market	144 to 148	430 to 440 or 438 to 450
MODE		F3E (FM)	
ANTENNA IMPEDANCE		50 Ω	
OPERATING TEMPERATURE		-20°C ~ +60°C (-4°F~140°F)	
POWER REQUIREMENTS	DC IN (nominal)	6.3 V ~ 16 VDC (13.8 VDC)	
	BATTERY PACK	6.3 V ~ 16 VDC (7.2VDC)	
CURRENT DRAIN		Approx.	Approx.
Transmit mode(13.8VDC)		H 1.4A	1.5A
Transmit mode(13.8VDC)		L 0.5A	0.6A
Transmit mode(13.8VDC)		EL 120mA	150mA
SIMPLEX			
Receive mode with no signal		60mA	65mA
SIMPLEX Battery Save mode		10mA	12mA
DUPLEX			
Receive mode with no signal		110mA	110mA
DUPLEX Battery Save mode		20mA	20mA
GROUND		Negative	
DIMENSION (W×H×D)		49.5×134×41 mm	

DIMENSION (Projection Included)	61.4 × 149.5 × 42mm
WEIGHT (Transceiver only)	270g
MICROPHONE INPEDANCE	2kΩ

TRANSMITTER

OUTPUT POWER	H (13.8VDC)	more than 5W	
	H (7.5VDC)	Approx. 2W	
	L	Approx. 0.5W	
	E L	Approx. 20mW	Approx. 10mW
MODULATION		Reactance	
MAX. FREQUENCY DEVIATION		± 5kHz	
SPURIOUS RADIATION		less than -60dB	

RECEIVER

CIRCUITRY	double conversion superheterodyne	
INTERMEDIATE FREQUENCY 1 ST IF	45.05MHz	58.525MHz
INTERMEDIATE FREQUENCY 2 ND IF	455 kHz	
SENSITIVITY (12dB SINAD)	less than 0.16μV (MAIN)	less than 0.18μV (MAIN)
	0.32μV (SUB)	0.32μV (SUB)
SQUELCH SENSITIVITY	less than 0.16μV	
SELECTIVITY - 6dB	more than 12kHz	
SELECTIVITY - 60B	less than 28kHz	
AUDIO OUTPUT POWER (10 % distortion)	More than 200 mW (across 8Ω load)	

- NOTES:
1. Circuit and ratings are subject to change without notice, due to development in technology.
 2. Recommended duty cycle : 1 minute Transmission, 3 minutes Reception

QUICK REFERENCE

Note : The plus symbol (+) means press two keys simultaneously. "then" means press two keys in sequence.
 "(1 second)" means press the key for longer than one (1) second.

<i>TO DO THIS</i>	<i>PRESS</i>
Temporarily change the volume or frequency of the band that cannot control	E.CHG
Determine if a frequency is in use before transmitting	MONI
The LCD illumination lamp lights	LAMP
Change the frequency in 1 MHz step	MHz
VFO mode	VFO
Memory channel recall mode	MR
Activate call channel function	CALL
Recall the received message	MSG
Exchange Main and Sub band contents	BAND
Activate all function (blue letters)	F
Memory data entering mode	M
Activate tone encoder	TONE
Exchange dual band reception or single band reception	DUAL
Select desired transmitter offset direction	SHIFT

<i>TO DO THIS</i>	<i>PRESS</i>
Activate Band scan	VFO (1 second)
Activate Memory channel scan	MR (1 second)
Activate CALL scan	CALL (1 second)
Select volume or encoder mode	F then E.CHG
The LCD illumination lamp lights at all times	F then LAMP
Memory shift	F then VFO
Activate VFO/Memory scan	F then MR
Activate VFO/Memory/Call scan	F then CALL
Turn message function on or off	F then MSG
Turn automatic band change function on or off	F then BAND
Activate PAGING mode	F then 1
Activate DTSS function	F then 2
Activate CTCSS function	F then 3
Activate alert function	F then 4
Activate tone alert function	F then 5

<i>TO DO THIS</i>	<i>PRESS</i>
Switching speaker output when a external speaker is connected	F then 6
Turn CLOCK function on or off	F then 7
Turn switch on timerfunction on or off	F then 8
Turn switch off timerfunction on or off	F then 9
Activate memory channel lock out function	F then 0
Turn KEY LOCK function on or off	F then M
Turn TX STOP function on or off	F then f ²
Select transmit output power level	F then TONE
Activate duplex operation	F then DUAL
Turn reverse function on or off	F then SHIFT
Return the encoder to the original setting mode	F (1 second) then E.CHG
Recalling stored DTMF cords	F (1 second) then MHz
Turn automatic power off function on or off	F (1 second) then VFO
Turn battery saver function on or off	F (1 second) then MR
Signaling squelch function on or off	F (1 second) then CALL

<i>TO DO THIS</i>	<i>PRESS</i>
Message memory recall	F (1 second) then MSG
Activate paging code selection mode	F (1 second) then 1
Activate DTSS code selection mode	F (1 second) then 2
Activate frequency step selection mode	F (1 second) then 3
Recall lower limit frequency of programmable band scan	F (1 second) then 4
Recall upper limit frequency of programmable band scan	F (1 second) then 5
Change the speaker output when a external speaker is connected	F (1 second) then 6
Activate Time setting function	F (1 second) then 7
Switch-on timer setting mode	F (1 second) then 8
Switch-off timer setting mode	F (1 second) then 9
Select tone frequency	F (1 second) then TONE

<i>TO DO THIS</i>	<i>PRESS</i>
Enter a data into the call channel	M then CALL
Message memory buffer clear	M (1 second) then MSG
Enter displayed data in lower limit frequency of programmable VFO tuning limit	M (1 second) then 1
Enter displayed data in upper limit frequency of programmable VFO tuning limit	M (1 second) then 2
Enter displayed frequency in lower limit frequency of programmable band scan	M (1 second) then 4
Enter displayed frequency in upper limit frequency of programmable band scan	M (1 second) then 5
Select encoder mode	E,CHG + POWER
Select 2 or 3 digit memory channel recall using numeric key pad	MR + POWER
Turn automatic shift function on or off	BAND + POWER
Reset VFO	F + POWER
Reset memory	M + POWER
Turn the message memory function on or off	f ² + POWER

<i>TO DO THIS</i>	<i>PRESS</i>
Answer-Back on or off	MHz + POWER
Delay time selection	1 + POWER
DTMF delay time selection	2 + POWER
Channelized frequency display on or off	3 + POWER
Turn earphone mode on or off	4 + POWER
Selecting a beep sound	5 + POWER
Turn beep function on or off	6 + POWER
Battery save time selection	7 + POWER
Hold/Resume selection(VHF band)	8 + POWER
Hold/Resume selection(UHF band)	9 + POWER

KENWOOD